

Castor wheel
manufacturers

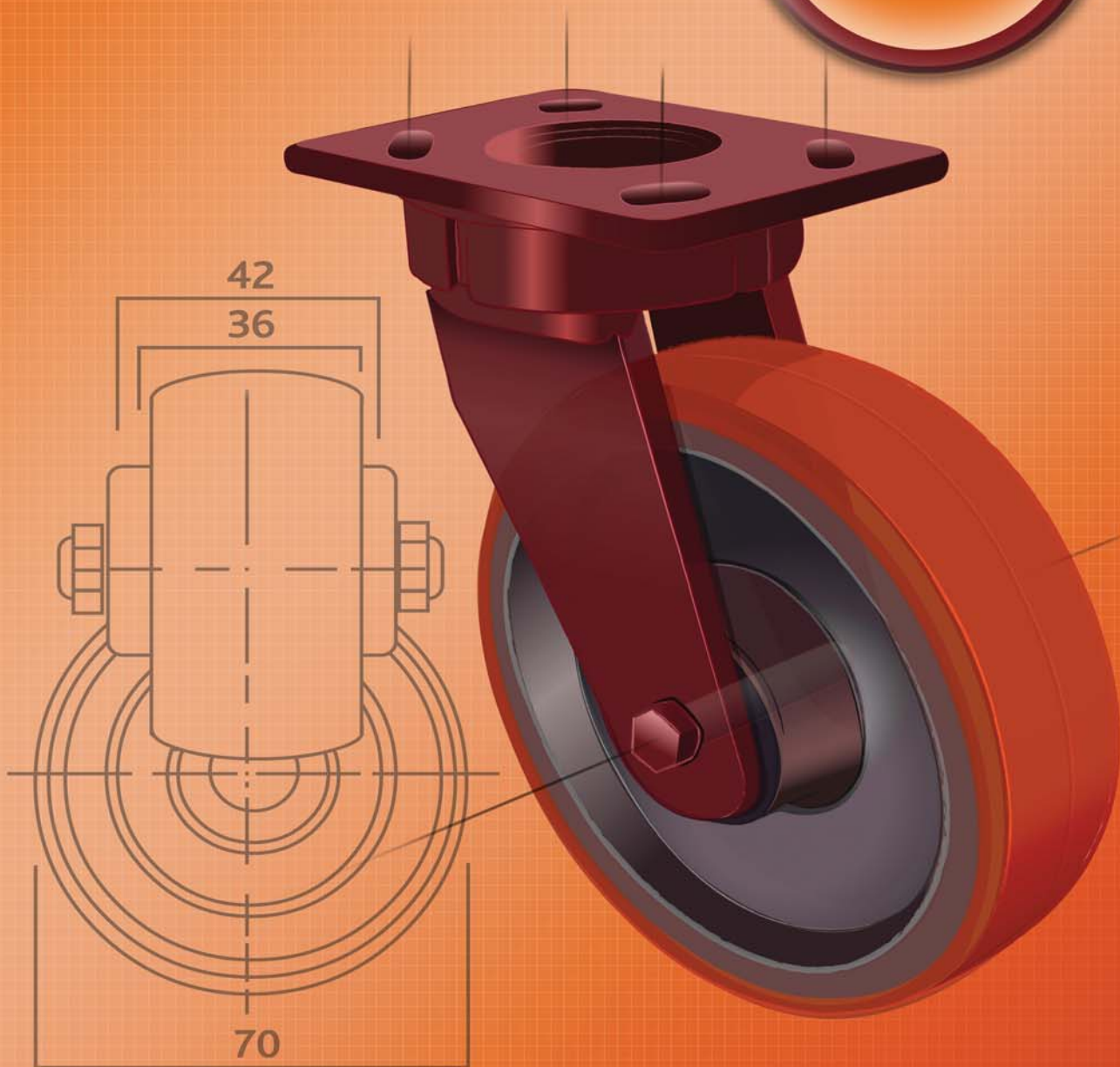

BAZROLL INTERNATIONAL LTD

Tel: 01249 822 222

www.bilgroup.eu



WPL SERIES

Solid white or black polypropylene wheels.
Temperature range: -20°C to +80°C

Wheel diameter (mm)	Tread width (mm)	Bore size (mm)	Hub length (mm)	Plain bearing	Needle roller bearing
---------------------	------------------	----------------	-----------------	---------------	-----------------------

BLACK POLYPROPYLENE

50	17	8	20	BZL50WPL 50kg	–
75	25	8	26	BZL75WPL 70kg	–
80	32	12	39	BZMM80WPLBLK 70kg	–
100	36	12	39	BZML100WPLBLK 125kg	–

WHITE POLYPROPYLENE

80	32	12	39	BZMM80WPL 70kg	–
	36	12	39	BZML100WPL 125kg	BZML100WPLRB 125kg
100	32	12	44	BZMM100WPL 125kg	BZMM100WPLRB 125kg
	32	20	44	BZH100WPL20 125kg	–
	35	12	39	BZML125WPL 140kg	–
125	35	12	44	BZMM125WPL 140kg	BZMM125WPLRB 140kg
	35	20	44	BZMM125WPL20 140kg	–
	40	15	44	BZMH125WPL 140kg	BZMH125WPLRB 140kg

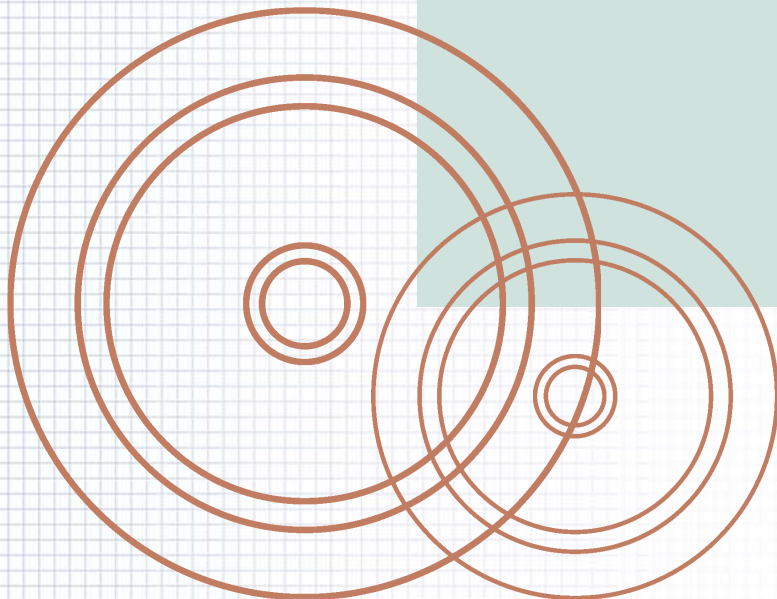
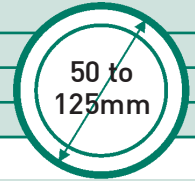

WNY SERIES

Solid white nylon (polyamide 6) wheels.

Temperature range: -30°C to +80°C

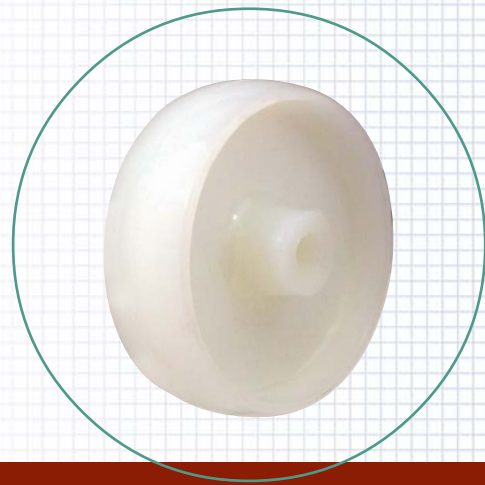

60-1200kg

Wheel diameter (mm)	Tread width (mm)	Bore size (mm)	Hub length (mm)	Plain bearing	Needle roller bearing	Ball journal bearing
---------------------	------------------	----------------	-----------------	---------------	-----------------------	----------------------

WHITE NYLON

Wheel diameter (mm)	Tread width (mm)	Bore size (mm)	Hub length (mm)	Plain bearing	Needle roller bearing	Ball journal bearing
50	17	8	20	BZV050WNY1 60kg	-	-
	20	8	24	BZV050WNY2 80kg	-	-
60	35	12	39	BZMM60WNY 150kg	-	-
63	23	9.5	33	BZMM63WNY 120kg	-	-
75	25	8	26	BZL75WNY 90kg	-	-
	28	12	39	BZMM75WNY 150kg	-	-
80	30	12	39	BZMM80WNY 150kg	BZMM80WNYRB 150kg	-
	30	12	44	BZMH80WNY 180kg	BZMH80WNYRB 180kg	-
100	30	12	39	BZMM100WNY 180kg	BZMM100WNYRB 180kg	-
	32	12	44	BZV100WNY4 270kg	BZV100WNYRB4 270kg	-
	32	20	44	BZH100WNY20 270kg	-	-
	32	15	48	BZH100WNY61 270kg	BZH100WNYRB61 270kg	-
	35	15	44	-	-	BZXH100WNYBJM15 400kg
125	35	20	44	BZXH100WNY20 400kg	-	-
	35	12	44	BZV125WNY4 300kg	BZV125WNYRB4 300kg	-
	35	15	44	BZH125WNY 300kg	BZH125WNYRB 300kg	-
	35	20	44	BZH125WNY20 300kg	-	-
	35	15	48	BZH125WNY61 300kg	BZH125WNYRB61 300kg	-
	40	20	50	-	-	BZH125WNYBJM20 500kg
150	45	20	58	BZXH125WNY 750kg	BZXH125WNYRB 750kg	BZXH125WNYBJM20 750kg
	40	15	44	BZMM150WNY 300kg	BZMM150WNYRB 300kg	-
	40	20	50	BZL150WNY 350kg	-	BZH150WNYBJM20 500kg
	45	20	58	BZVL150WNY5 350kg	BZVL150WNYRB5 350kg	-
	45	20	58	-	-	BZH150WNYBJM2060 700kg
160	45	20	58	BZV150WNY5 800kg	BZV150WNYRB5 800kg	BZXH150WNYBJM20 800kg
	45	20	58	BZH160WNY 350kg	BZH160WNYRB 350kg	-
	50	20	58	BZVL200WNY5 500kg	BZVL200WNYRB5 500kg	-
200	50	20	50	-	-	BZH200WNYBJM20 650kg
	50	20	58	-	-	BZH200WNYBJM2060 650kg
	50	20	58	BZV200WNY5 1000kg	BZV200WNYRB5 1000kg	BZXH200WNYBJM20 1000kg
250	50	25	60	BZH250WNY25 930kg	-	-
	50	25	50	-	-	BZH250WNYBJM25 1200kg

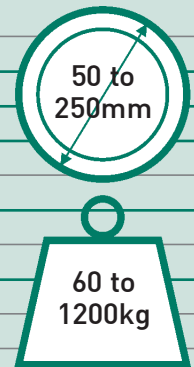

WNY SERIES NYLON





WCI SERIES

Solid cast iron wheels.

Wheel diameter (mm)	Tread width (mm)	Bore size (mm)	Hub length (mm)	Plain bearing	Needle roller bearing	Ball journal bearing
75	32	12	39	BZMM75WCI 100kg	–	–
80	32	12	39	BZMM80WCI 130kg	–	–
100	35	12	39	BZMM100WCI 240kg	–	–
		12.7	39	BZMM100WCI/127 240kg	–	–
	38	12	45	–	BZMH100WCI RBM12 260kg	–
		20	45	BZMH100WCI M20 260kg	–	–
50	15	48	BZH100WCI 270kg	BZH100WCI RBM15 270kg	–	
		23	48	BZH100WCI M23 270kg	–	–
	20	60	BZXH100WCI M20 400kg	BZXH100WCI RBM20 400kg	BZXH100WCI BJM20 400kg	
125	35	12	44	–	BZMH125WCI RBM12 350kg	–
		15	44	BZMH125WCI 350kg	–	–
	38	20	44	BZMH125WCI M20 350kg	–	BZMH125WCI BJM20 350kg
		15	48	BZH125WCI 350kg	BZH125WCI RBM15 350kg	–
	23	48	BZH125WCI M23 350kg	–	–	
50	20	60	BZXH125WCI M20 550kg	BZXH125WCI RBM20 550kg	BZXH125WCI BJM20 550kg	
150	50	20	60	BZH150WCI M20 910kg	BZH150WCI RBM20 910kg	BZH150WCI BJM20 910kg
200	50	20	60	BZH200WCI M20 1000kg	BZH200WCI RBM20 1000kg	BZH200WCI BJM20 1000kg
250	50	20	60	–	–	BZH250WCI BJM20 1250kg

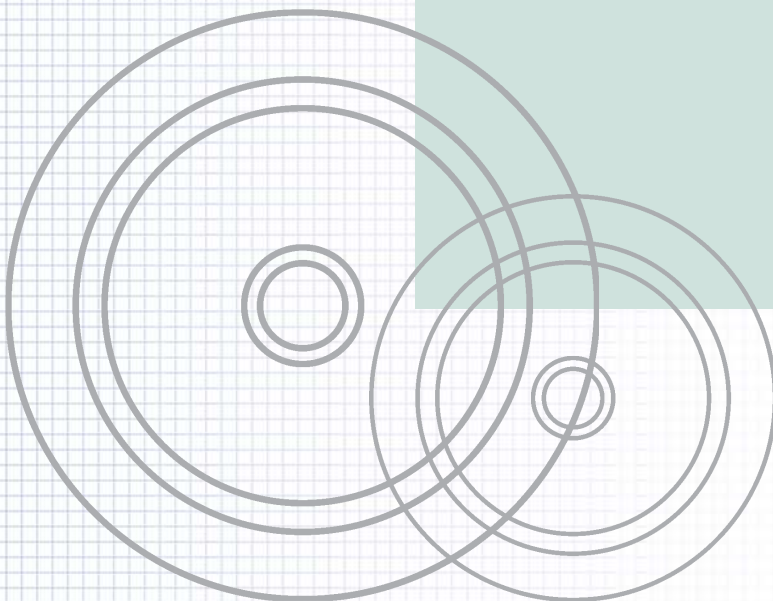
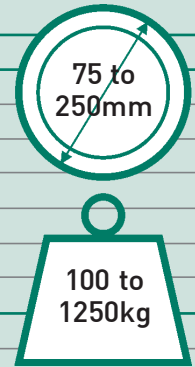

WST SERIES

Solid ductile steel wheels.

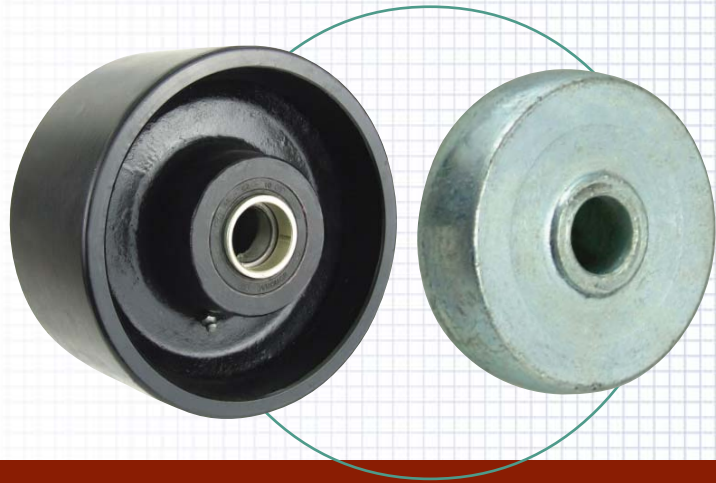

135-5500kg

Wheel diameter (mm)	Tread width (mm)	Bore size (mm)	Hub length (mm)	Plain bearing 	Ball journal bearing 	Taper roller bearing 
---------------------	------------------	----------------	-----------------	---	--	--

50	14	12	17	BZH50WST 135kg	-	-
150	50	25	60	-	BZH150WSTBJM25 910kg	-
200	50	25	60	-	BZH200WSTBJM25 1100kg	-
	100	30	108	-	-	BZXXH200WSTTM30 3600kg
250	100	30	108	-	-	BZXXH250WSTTM30 5450kg
300	100	30	108	-	-	BZXXH300WSTTM30 5500kg

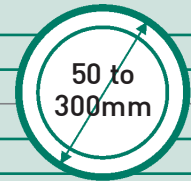

WST SERIES STEEL





WAN SERIES

Solid phenolic wheels suitable for high temperature applications.

Wheel diameter (mm)	Tread width (mm)	Bore size (mm)	Hub length (mm)	Plain bearing	Needle roller bearing	Ball journal bearing	Sintered bronze bearing
---------------------	------------------	----------------	-----------------	---------------	-----------------------	----------------------	-------------------------

BLACK PHENOLIC -30°C to +120°C

75	38	12	41	WAN75M12/120 150kg	-	-	-
100	38	15	41	WAN100M15/120 305kg	-	-	-
		14.3	41	-	WAN100RB143/120 305kg	-	-
125	38	51	56	-	WAN100RB191/120 305kg	-	-
		15	41	WAN125M15/120 395kg	-	-	-
150	51	19.1	56	-	WAN125RB143/120 395kg	-	-
		19.1	56	-	WAN125RB191/120 395kg	-	-
200	51	19.1	56	-	WAN150RB191/120 540kg	-	-
200	51	19.1	56	-	WAN200RB191/120 725kg	-	-

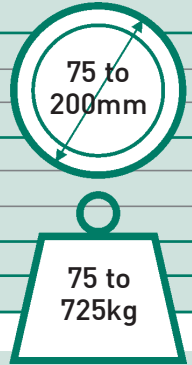

BROWN PHENOLIC -30°C to +250°C

75	38	12	41	WAN75M12/250 75kg	-	-	-
100	38	15	41	WAN100M15/250 150kg	-	-	-
125	38	15	41	WAN125M15/250 200kg	-	-	-
150	51	19.1	56	-	WAN150RB191/250 270kg	-	-
200	51	19.1	56	-	WAN200RB191/250 360kg	-	-

BLACK PHENOLIC -40°C to +300°C

80	35	12	40	WAN80M12/300 150kg	-	WAN80BJM12/300 150kg	-
		12	40	WANL100M12/300 160kg	-	-	-
100	35	12	40	WAN100M12/300 180kg	-	WAN100BJM12/300 180kg	-
		15	41	WANL100M15/300 180kg	-	-	-
125	40	15	45	-	-	-	WAN125M15S/300 250kg
		20	50	-	-	-	WAN125M20S/300 250kg
150	45	20	58	-	-	-	WAN150M20S/300 300kg
200	50	20	58	-	-	-	WAN200M20S/300 300kg

RED PHENOLIC -40°C to +350°C

100	35	15	40	WAN100M15/300 250kg	-	-	-
-----	----	----	----	---------------------	---	---	---

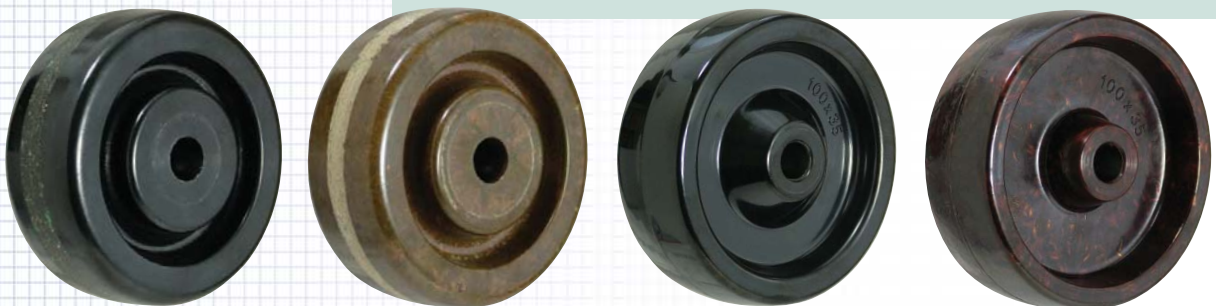

WTP/WRNHT SERIES

Solid black thermoplastic and black rubber tyre on phenolic wheels suitable for high temperature applications.

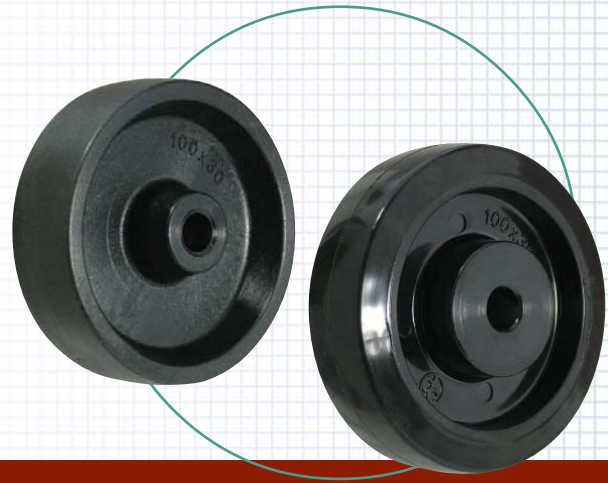

110-180kg

Wheel diameter (mm)	Tread width (mm)	Bore size (mm)	Hub length (mm)	Plain bearing	Ball journal bearing
---------------------	------------------	----------------	-----------------	---------------	----------------------

BLACK THERMOPLASTIC -40°C to +300°C

100	35	12	40	WTP100M12/300 180kg	WTP100BJM12/300 180kg
-----	----	----	----	---------------------	-----------------------

BLACK RUBBER ON PHENOLIC -40°C to +250°C

100	30	12	40	BZMM100WRN12/250 110kg	BZMM100WRNBJM12/250 110kg
-----	----	----	----	------------------------	---------------------------

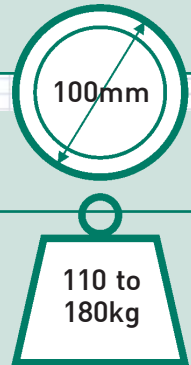

WTP/WRNHT SERIES HIGH TEMP

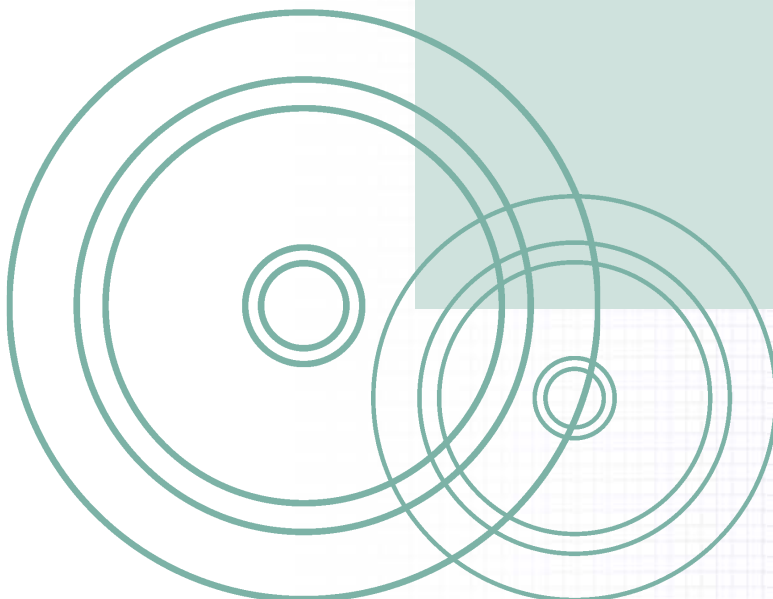

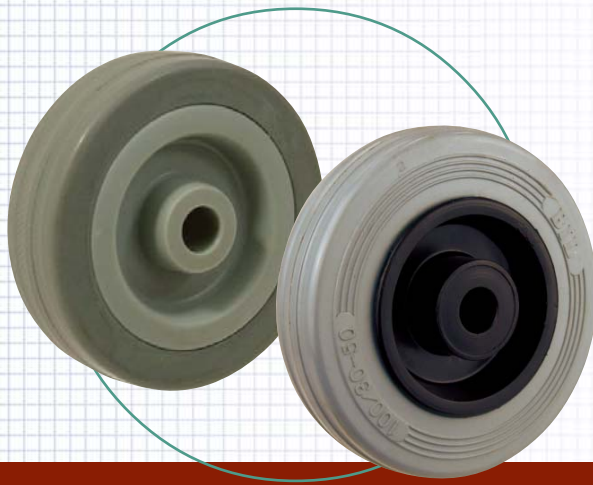

WGR SERIES

Grey rubber tyre on polypropylene rim.

Hardness: 85±3 Shore A

Temperature range: -20°C to +60°C

Wheel diameter (mm)	Tread width (mm)	Bore size (mm)	Hub length (mm)	Plain bearing	Needle roller bearing	Ball journal bearing
---------------------	------------------	----------------	-----------------	---------------	-----------------------	----------------------

LIGHT DUTY

50	18	8	22	BZD50WGR 40kg	-	-
75	21	10	27	BZD75WGR 70kg	-	-
100	30	8	36	-	-	BZM100WGRBJM8 80kg
125	30	8	36	-	-	BZM125WGRBJM8 100kg

MEDIUM DUTY

80	25	12	40	BZMM80WGR 50kg	BZMM80WGRRB 50kg	-
100	30	12	40	BZMM100WGR 70kg	BZMM100WGRRB 70kg	-
		12	40	BZML125WGR 90kg	-	-
125	37.5	12	45	BZMM125WGR12 90kg	-	-
		15	45	BZMM125WGR 90kg	BZMM125WGRRB 90kg	-
150	40	15	45	BZMM150WGR 110kg	BZMM150WGRRB 110kg	-
160	40	20	60	BZH160WGR 140kg	BZH160WGRRB 140kg	-
200	50	20	60	BZH200WGR 205kg	BZH200WGRRB 205kg	-

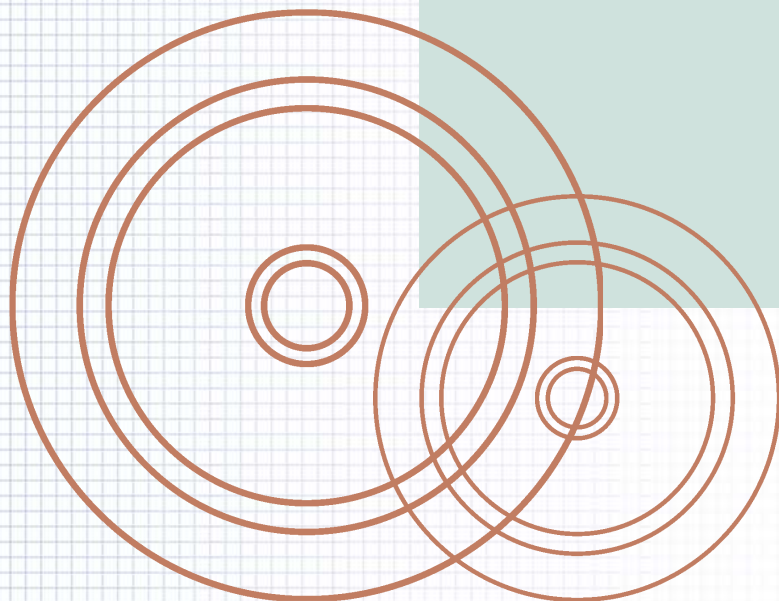
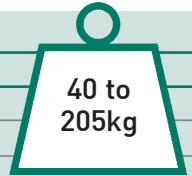
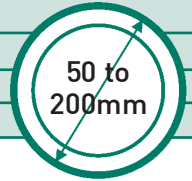

WVGR/WTPR SERIES

Grey rubber tyre on polypropylene rim.
 Hardness: 87 ± 3 Shore A
 Temperature range: -10°C to +50°C

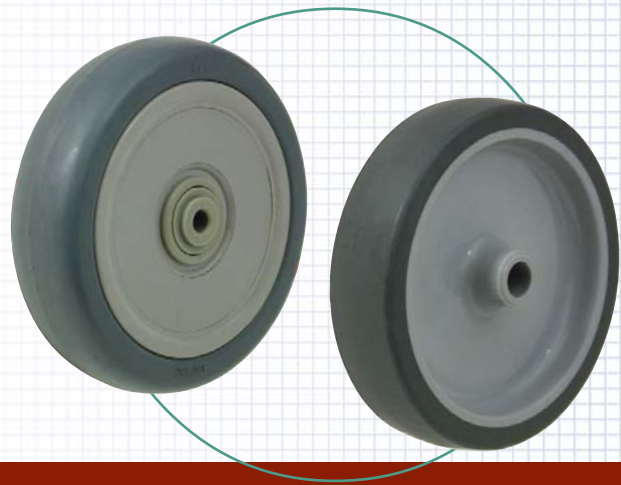

40-100kg

Wheel diameter (mm)	Tread width (mm)	Bore size (mm)	Hub length (mm)	Plain bearing	Ball journal bearing
---------------------	------------------	----------------	-----------------	---------------	----------------------

GREY VULCANISED RUBBER ON GREY POLYPROPYLENE CENTRE

50	18	8	21	BZL50WVGR 40kg	–
60	22	10	29	BZL60WVGR 45kg	–
75	24	10	29	BZL75WVGR 50kg	–
		6	29	–	BZL75WVGRBJM6 50kg
80	24	10	29	BZL80WVGR 55kg	–
	24	10	29	BZL100WVGR 60kg	–
100	30	12	34	BZM100WVGR 80kg	–
	30	8	34	–	BZM100WVGRBJM8 80kg
125	30	12	34	BZM125WVGR 100kg	–
		8	34	–	BZM125WVGRBJM8 100kg

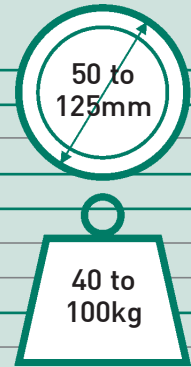

GREY THERMOPLASTIC TYRE ON GREY POLYPROPYLENE CENTRE

100	30	12	36	BZM100WTPRM12 80kg	–
		8	36	–	BZM100WTPRBJM8 80kg
125	30	12	36	BZM125WTPRM12 100kg	–
		8	36	–	BZM125WTPRBJM8 100kg

WVGR/WTPR SERIES RUBBER/POLY





WPS SERIES

Black solid rubber tyre on polypropylene rim.
 Hardness: 85±3 Shore A
 Temperature range: -20°C to +60°C

Wheel diameter (mm)	Tread width (mm)	Bore size (mm)	Hub length (mm)	Plain bearing	Needle roller bearing
80	25	12	40	BZMM80WPS 50kg	BZMM80WPSRB 50kg
100	30	12	40	BZMM100WPS 70kg	BZMM100WPSRB 70kg
125	37.5	12	40	BZML125WPS12 90kg	-
		12	45	BZMM125WPS12 90kg	-
150	40	15	45	BZMM125WPS 90kg	BZMM125WPSRB 90kg
		15	45	BZMM150WPS 110kg	BZMM150WPSRB 110kg
160	40	20	60	BZH160WPS 160kg	BZH160WPSRB 160kg
200	50	20	60	BZH200WPS 205kg	BZH200WPSRB 205kg

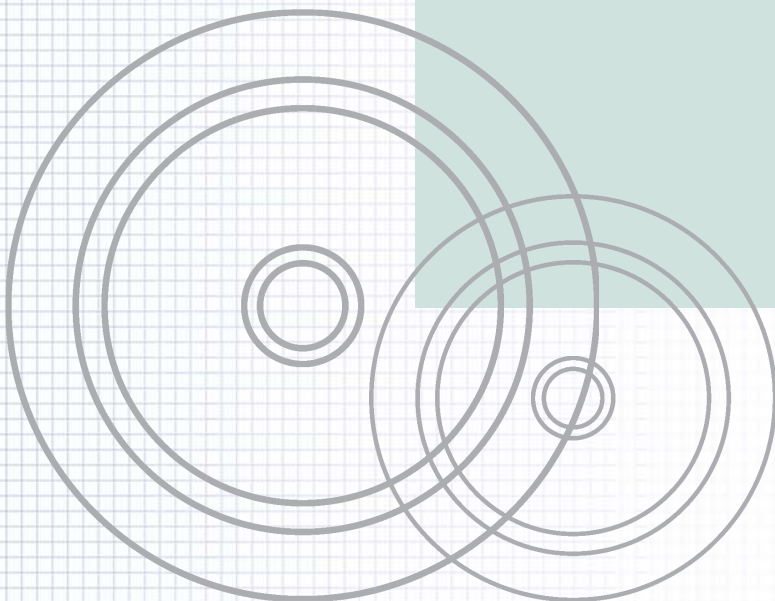
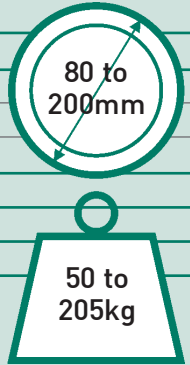

WBS SERIES

Black solid rubber tyre on welded, zinc-plated steel rim.

Hardness: 85±3 Shore A
Temperature range: -20°C to +60°C



50-205kg

Wheel diameter (mm)	Tread width (mm)	Bore size (mm)	Hub length (mm)	Needle roller bearing
---------------------	------------------	----------------	-----------------	-----------------------

80	25	12	40	BZML80WBSRB 50kg
100	30	12	40	BZML100WBSRB 70kg
125	37.5	15	45	BZMM125WBSRB 90kg
150	40	15	45	BZMM150WBSRB 110kg
160	40	20	60	BZH160WBSRB 160kg
200	50	20	60	BZH200WBSRB 205kg

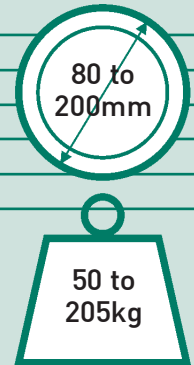

WBS SERIES RUBBER/STEEL

















120-350kg



WPK SERIES

Black solid rubber tyre on red polypropylene rim.

Hardness: 85±3 Shore A
Temperature range: -20°C to +60°C

Wheel diameter (mm)	Tread width (mm)	Bore size (mm)	Hub length (mm)	Plain bearing	Needle roller bearing
160	40	20	51		
200	50	25.4	51		
250	60	25.4	51		
260	95	25.4	59		
300	60	25.4	51		
355	90	25.4	66		
400	100	25.4	66		

160	40	20	51	BZWPK1602051 120kg	–
		25.4	51	BZWPK16025451 120kg	–
200	50	25.4	51	BZWPK20025451 205kg	BZWPKR20025451 205kg
		25	60	–	BZWPKR2502560 275kg
250	60	25.4	51	BZWPK25025451 275kg	BZWPKR25025451 275kg
260	95	25.4	59	BZWPK26025459 125kg	–
300	60	25.4	51	BZWPK30025451 280kg	BZWPKR30025451 280kg
355	90	25.4	66	BZWPK35525466 280kg	BZWPKR35525466 300kg
		25	66	–	BZWPKR4002566 350kg
400	100	25.4	66	BZWPK40025466 350kg	BZWPKR40025466 350kg

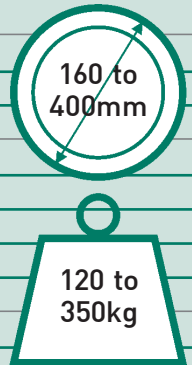

WPK SERIES RUBBER/POLY

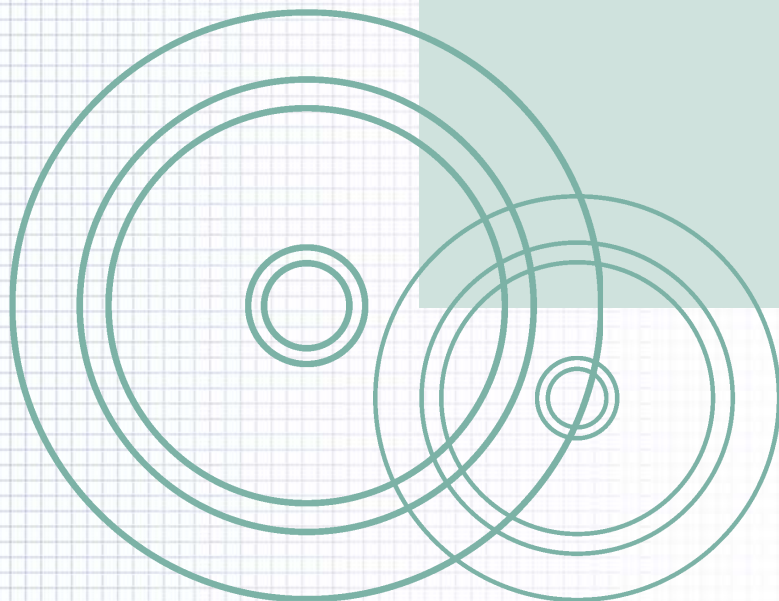

WMK SERIES

Black solid rubber tyre on bolted powder-coated steel rim.

Hardness: 85±3 Shore A
Temperature range: -20°C to +60°C



125-700kg

Wheel diameter (mm)	Tread width (mm)	Bore size (mm)	Hub length (mm)	Needle roller bearing	Ball journal bearing
200	50	25.4	51	BZWMKR20025451 205kg	-
250	60	25.4	51	BZWMKR25025451 350kg	-
		25	60	BZWMKR2502560 350kg	-
300	60	25.4	51	BZWMKR30025451 400kg	-
		25.4	66	BZWMKR35525466 400kg	-
355	80	25	75	-	BZWMKBJ3552575 400kg
		25.4	75	-	BZWMKBJ35525475 400kg
		25.4	66	BZWMKR40025466 700kg	-
400	100	25	75	-	BZWMKBJ4002575 700kg
		25.4	75	-	BZWMKBJ40025475 700kg

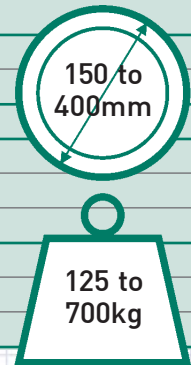

STAIRCLIMBER WHEELS

150	40	20	64	-	BZMM150WBSRB/STAIR 90kg	-
-----	----	----	----	---	-------------------------	---

Specially designed to be mounted onto sack trucks to enable movement of loads up flights of stairs.



WMK SERIES RUBBER/STEEL



30-50kg



WPD SERIES

Black solid rubber tyre on white polypropylene rim. Available with two different coloured endcaps.

Hardness: 85±3 Shore A
Temperature range: -20°C to +50°C

Wheel diameter (mm)	Tread width (mm)	Bore size (mm)	Hub length (mm)	Plain bearing
---------------------	------------------	----------------	-----------------	---------------

150	35	12.7	38	BZWPD15012738 30kg
180	43	12.7	38	BZWPD18012738 50kg
200	43	12.7	38	BZWPD20012738 50kg

Black cap order

BZWPD CAPBLACK

Red cap order

BZWPD CAPRED

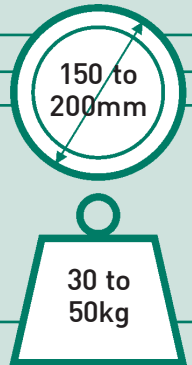

WPD SERIES RUBBER/POLY

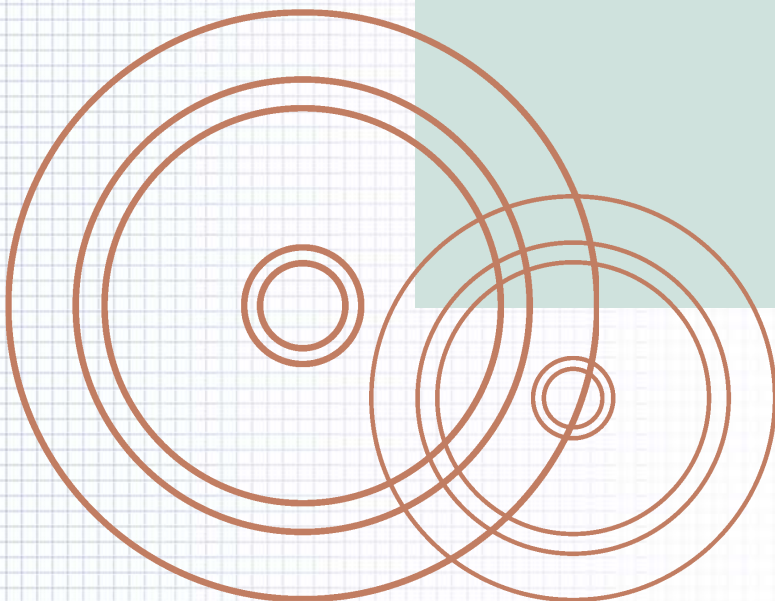

WRN SERIES

Blue elastic rubber tyre on black nylon (polyamide 6) rim.

Hardness: 70±3 Shore A
Temperature range: -20°C to +60°C

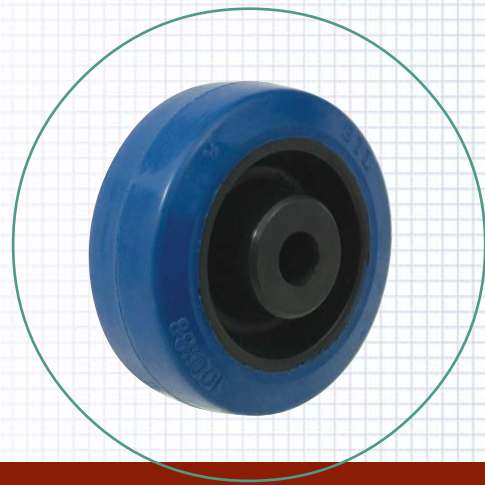

40-500kg

Wheel diameter (mm)	Tread width (mm)	Bore size (mm)	Hub length (mm)	Plain bearing	Needle roller bearing	Ball journal bearing
---------------------	------------------	----------------	-----------------	---------------	-----------------------	----------------------

Wheel diameter (mm)	Tread width (mm)	Bore size (mm)	Hub length (mm)	Plain bearing	Needle roller bearing	Ball journal bearing
50	22	6.4	24	BZMM50WRN 40kg	-	-
65	35	12	40	BZMH65WRN 80kg	-	-
75	35	12	40	BZMM75WRN 90kg	-	-
80	35	12	40	BZMH80WRN 100kg	-	-
100	32	12	40	BZMM100WRN 160kg	BZMM100WRNRB 160kg	-
	40	15	48	BZH100WRN15 250kg	BZH100WRNRB15 250kg	-
125	36	15	45	BZMH125WRN 200kg	BZMH125WRNRB 200kg	-
	40	15	48	BZH125WRN15 250kg	BZH125WRNRB15 250kg	-
	50	20	60	-	BZH125WRNRB20 275kg	-
150	50	20	60	BZH150WRN 300kg	BZH150WRNRB 300kg	-
160	50	20	50	-	-	BZMH160WRNBJM20 300kg
			60	-	BZH160WRNRB 300kg	BZH160WRNBJM20 300kg
200	50	20	50	-	-	BZMH200WRNBJM20 400kg
			60	BZH200WRN 400kg	BZH200WRNRB 400kg	BZH200WRNBJM20 400kg
250	50	25	60	-	BZH250WRNRB 500kg	-
	60	25	60	-	-	BZH250WRNBJM25 500kg

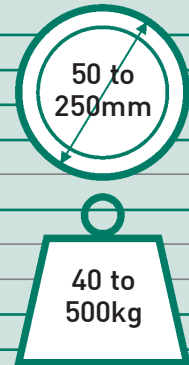

• Wheels also available with grey tyres – details available on request

WRN SERIES RUBBER/NYLON



160-800kg



WER SERIES

Elastic rubber tyre on aluminium rim.

Hardness: 65±3 Shore A

Temperature range: -20°C to +70°C

Wheel diameter (mm)	Tread width (mm)	Bore size (mm)	Hub length (mm)	Ball journal bearing
---------------------	------------------	----------------	-----------------	----------------------

100	40	15	40	BZH100WERBJM15 160kg
125	50	20	60	BZH125WERBJM20 225kg
160	50	20	60	BZH160WERBJM20 350kg
180	50	20	60	BZH180WERBJM20 350kg
200	50	20	60	BZH200WERBJM20 450kg
	60	20	60	BZH200WERBJM20WT 450kg
250	50	20	60	BZH250WERBJM20 500kg
	75	25	83	BZXH250WERBJM25 625kg
300	80	30	83	BZH300WERBJM30 800kg

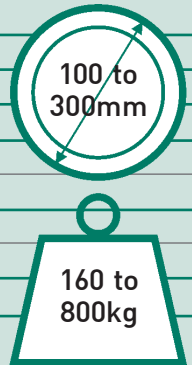

- Wheels also available with grey tyres – details available on request

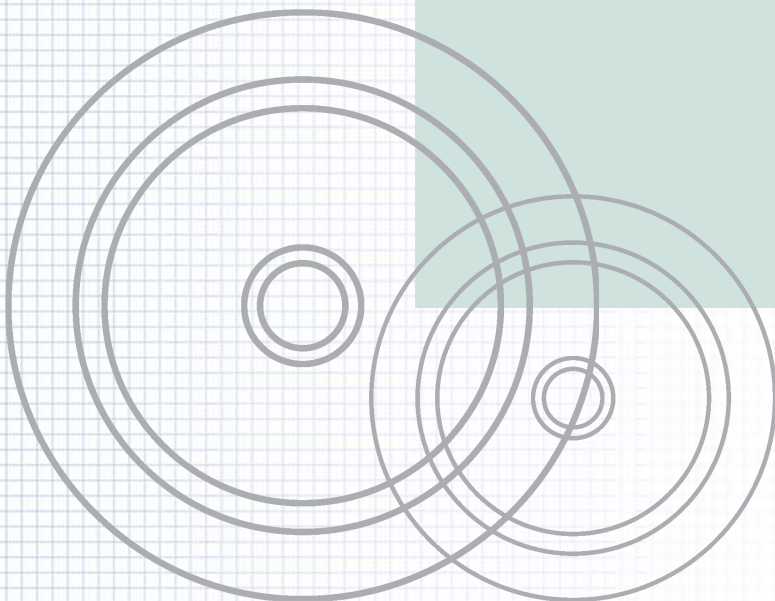

WER SERIES RUBBER/ALUMINIUM

WCR/WCU SERIES

Elastic rubber tyre on cast-iron rim.

Hardness: 75±3 Shore A

Temperature range: -20°C to +60°C

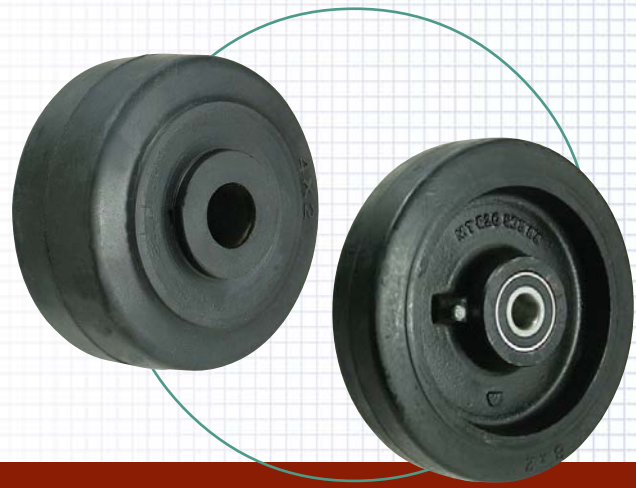

160-1050kg

Wheel diameter (mm)	Tread width (mm)	Bore size (mm)	Hub length (mm)	Plain bearing	Needle roller bearing	Ball journal bearing
---------------------	------------------	----------------	-----------------	---------------	-----------------------	----------------------

100	38	12	45	–	BZMH100WCRRB12 160kg	–
	38	15	48	–	BZH100WCRRB15 160kg	–
	38	20	45	BZMH100WCRM20 160kg	–	BZMH100WCRBJM20 160kg
	38	23	50	BZH100WCRM23 160kg	–	–
	50	20	50	–	–	BZH100WCRBJM20 210kg
125	38	12	45	–	BZMH125WCRRB12 190kg	–
	38	15	48	–	BZH125WCRRB15 190kg	–
	38	20	45	BZMH125WCRM20 190kg	–	BZMH125WCRBJM20 190kg
	38	23	48	BZH125WCRM23 190kg	–	–
	50	20	60	BZH125WCRM20 300kg	BZH125WCRRB20 300kg	BZH125WCRBJM20 300kg
150	50	20	60	BZH150WCRM20 300kg	BZH150WCRRB20 300kg	BZH150WCRBJM20 300kg
	50	25.4	60	–	BZH150WCRRB254 300kg	–
	50	20	60	BZHL200WCRM20 450kg	BZHL200WCRRB20 450kg	BZHL200WCRBJM20 450kg
200	50	25.4	60	–	BZHL200WCRRB254 450kg	–
	50	25	60	–	–	BZH200WCRBJM25 600kg
	75	25	82	–	–	BZXH200WCRBJM25 600kg
	50	20	60	–	–	BZHL250WCRBJM20 500kg
250	50	25.4	60	–	BZHL250WCRRB254 500kg	–
	75	25	82	–	–	BZH250WCRBJM25 750kg
	100	30	108	–	–	BZXXH250WCRBJM30 1020kg
300	75	25	82	–	–	BZXH300WCRBJM25 850kg
400	75	30	92	–	–	BZMH400WCRBJM30 1050kg
SPEED WHEELS – 16 kph intermittent						4 kph
150	50	20	60	–	–	BZH150WCUBJM20 300kg*
200	50	20	60	–	–	BZHL200WCUBJM20 450kg**

* at 16kph 120kg

** at 16kph 180kg

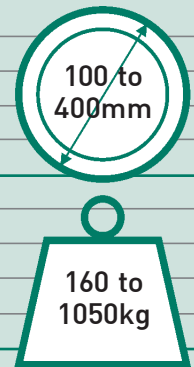

WCR/WCU SERIES RUBBER/CAST IRON



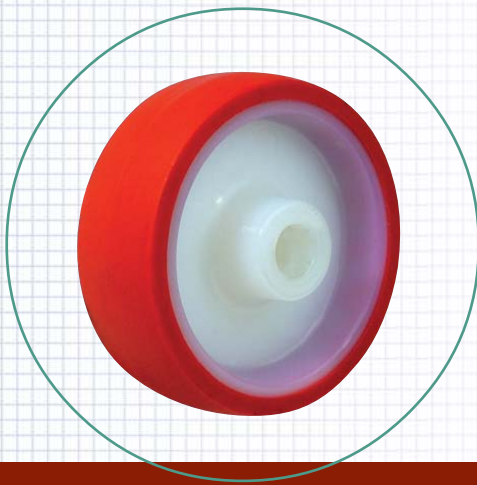

WNP SERIES

Red polyurethane tyre on nylon (polyamide 6) rim.

Hardness: 92 ± 2 Shore A

Temperature range: -20°C to +70°C

Wheel diameter (mm)	Tread width (mm)	Bore size (mm)	Hub length (mm)	Plain bearing	Needle roller bearing	Ball journal bearing
---------------------	------------------	----------------	-----------------	---------------	-----------------------	----------------------

80	30	12	40	BZML80WNP 200kg	BZML80WNPRB 200kg	-
	33	12	45	BZMM80WNP 210kg	BZMM80WNPRB 210kg	-
100	30	12	40	BZMM100WNP 230kg	BZMM100WNPRB 230kg	-
	33	12	45	BZH100WNP12 250kg	BZH100WNPRB12 250kg	-
125	33	15	48	BZH100WNP61 250kg	BZH100WNPRB61 250kg	-
	35	15	45	BZH125WNP 300kg	BZH125WNPRB 300kg	-
	35	15	48	BZH125WNP61 300kg	BZH125WNPRB61 300kg	-
	40	20	58	BZH125WNP20 350kg	BZH125WNPRB20 350kg	-
150	40	20	50	-	-	BZH125WNPBJM20 350kg
	40	15	45	BZMM150WNP 300kg	BZMM150WNPRB 300kg	-
	40	20	58	BZH150WNP 500kg	BZH150WNPRB 500kg	-
200	40	20	50	-	-	BZH150WNPBJM20 500kg
	50	20	58	BZH200WNP 600kg	BZH200WNPRB 600kg	-
	50	20	50	-	-	BZH200WNPBJM20 600kg

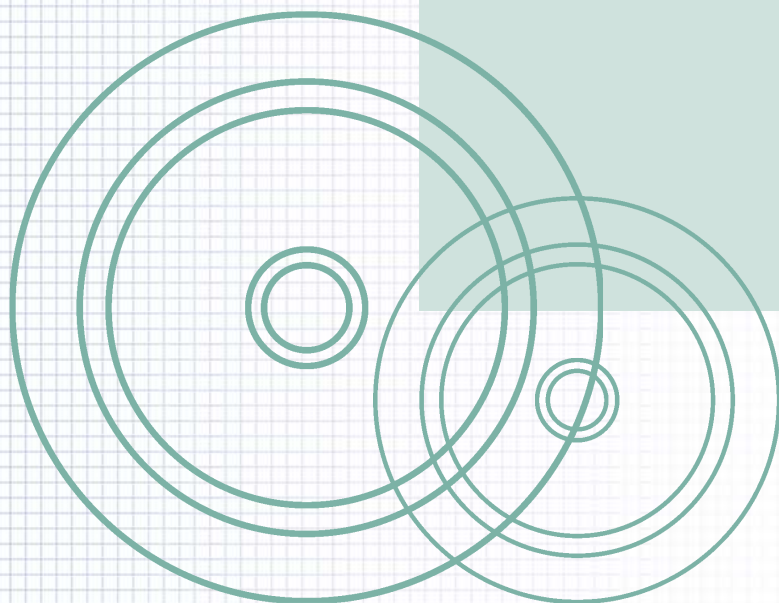
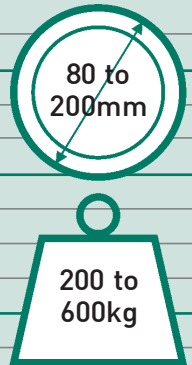

WPN SERIES

Brown polyurethane tyre on nylon (polyamide 6) rim.

Hardness: 92±2 Shore A
Temperature range: -20°C to +60°C

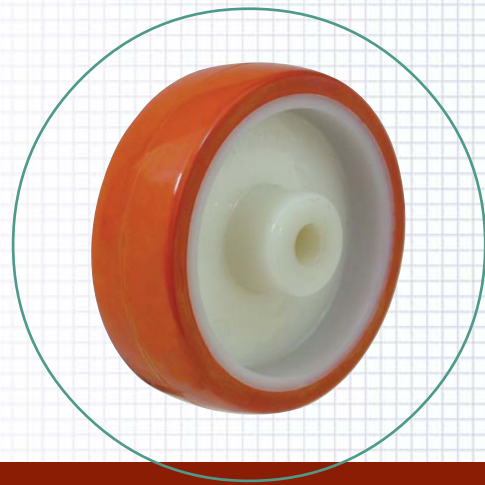

100-450kg

Wheel diameter (mm)	Tread width (mm)	Bore size (mm)	Hub length (mm)	Plain bearing	Needle roller bearing

80	30	12	40	BZMM80WPN 100kg	BZMM80WPNRB 100kg
100	30	12	40	BZMM100WPN 150kg	BZMM100WPNRB 150kg
	35	12	45	BZH100WPN 150kg	BZH100WPNRB 150kg
125	35	15	45	BZMM125WPN 200kg	BZMM125WPNRB 200kg
200	50	20	58	BZH200WPN 450kg	BZH200WPNRB 450kg

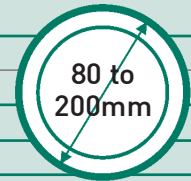

WPN SERIES POLY/NYLON



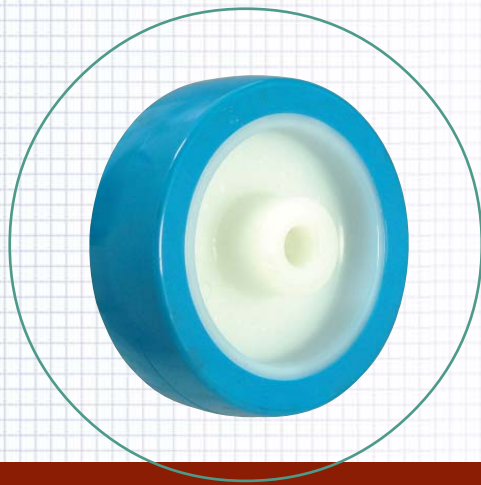

WENP SERIES

Blue soft polyurethane tyre on nylon (polyamide 6) rim.

Hardness: 82 ± 0 Shore A

Temperature range: -20°C to +60°C

Wheel diameter (mm)	Tread width (mm)	Bore size (mm)	Hub length (mm)	Plain bearing	Needle roller bearing	Ball journal bearing
---------------------	------------------	----------------	-----------------	---------------	-----------------------	----------------------

80	33	12	45	BZMM80WENP 210kg	BZMM80WENPRB 210kg	-
100	33	12	45	BZH100WENP 250kg	BZH100WENPRB 250kg	-
	40	15	47	-	BZH100WENPRB15 300kg	-
125	35	15	45	BZH125WENP 250kg	BZH125WENPRB 250kg	-
	40	20	50	-	-	BZH125WENPBJM20 300kg
150	40	15	45	-	BZMM150WENPRB 200kg	-
	40	20	58	BZH150WENP 280kg	BZH150WENPRB 280kg	-
	40	20	50	-	-	BZH150WENPBJM20 280kg
200	50	20	58	BZH200WENP 500kg	BZH200WENPRB 500kg	-
	50	20	50	-	-	BZH200WENPBJM20 500kg

80 to
200mm

210 to
500kg

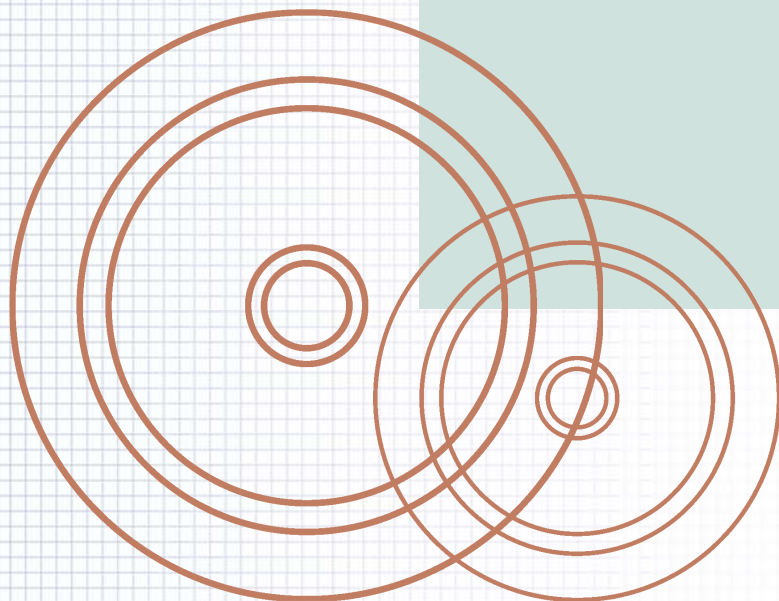

WPU SERIES

Red polyurethane tyre on polypropylene rim.

Hardness: 95±2 Shore A

Temperature range: -20°C to +60°C



200-300kg

Wheel diameter (mm)	Tread width (mm)	Bore size (mm)	Hub length (mm)	Needle roller bearing
---------------------	------------------	----------------	-----------------	-----------------------

100	50	19.1	60	BZH100WPURB 200kg
125	50	19.1	60	BZH125WPURB 220kg
150	50	19.1	60	BZH150WPURB 270kg
200	50	19.1	60	BZH200WPURB 300kg

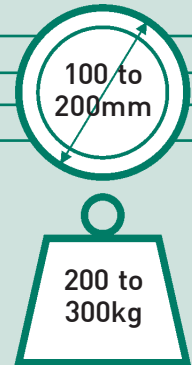

WPU SERIES POLY/POLYPROPYLENE



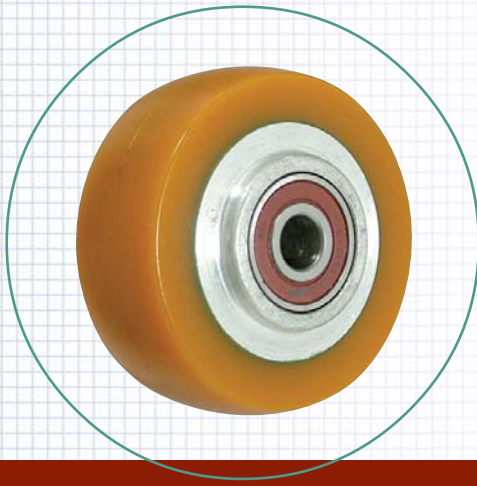

WPA SERIES

Brown polyurethane tyre on aluminium rim.
 Hardness: 95±3 Shore A
 Temperature range: -20°C to +80°C

Wheel diameter (mm)	Tread width (mm)	Bore size (mm)	Hub length (mm)	Ball journal bearing
---------------------	------------------	----------------	-----------------	----------------------

80	30	12	40	BZH80WPABJM12 200kg
100	40	15	45	BZH100WPABJM15 250kg
125	40	20	50	BZH125WPABJM20 300kg
150	40	20	50	BZH150WPABJM20 400kg
160	50	20	60	BZH160WPABJM20 500kg
200	50	20	60	BZH200WPABJM20 800kg

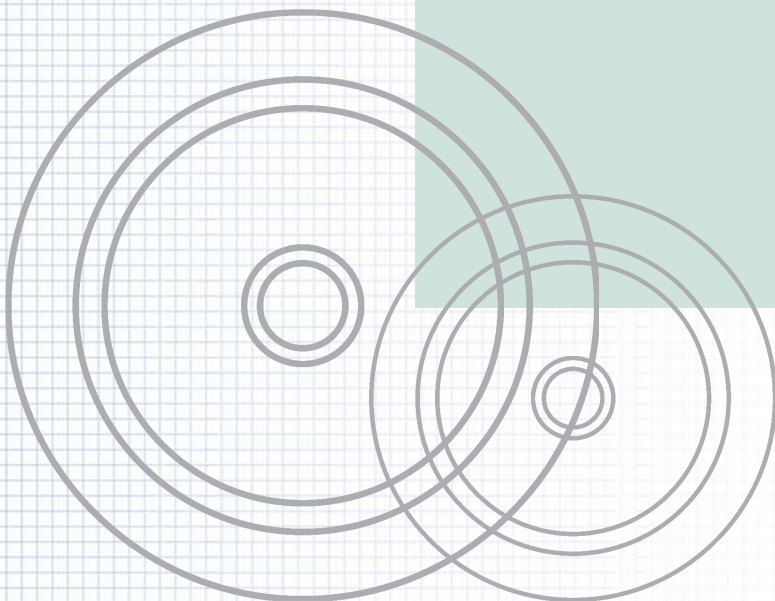
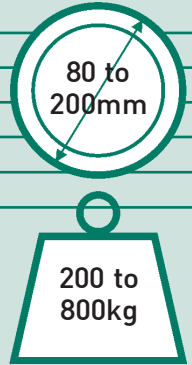

WPT/WSPT SERIES

Brown polyurethane tyre on black cast iron rim.

Hardness: 94 ± 3 Shore A
Temperature range: -20°C to +80°C

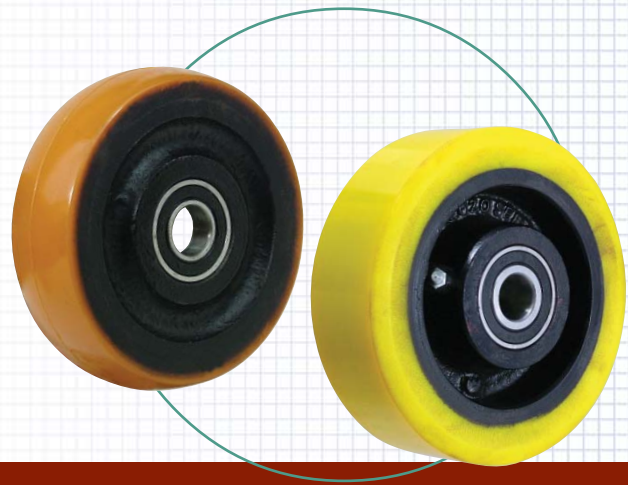

80-4500kg

Wheel diameter (mm)	Tread width (mm)	Bore size (mm)	Hub length (mm)	Plain bearing	Needle roller bearing	Ball journal bearing
50	14	12	17	BZH50WPT 80kg	-	-
60	35	12	37	-	-	BZH60WPTBJM12 180kg
75	30	12	40	BZH75WPTM12 150kg	-	-
	40	15	40	-	-	BZH75WPTBJM12 300kg
100	30	12	45	-	BZMH100WPTB12 250kg	-
	30	15	30	-	-	BZH100WPTBJM15 250kg
	30	20	45	BZMH100WPTM20 250kg	-	-
	40	15	50	-	BZH100WPTB15 300kg	-
	40	23	50	BZH100WPTM23 300kg	-	-
	40	20	40	-	-	BZPH100WPTBJM20 300kg
125	50	20	60	-	-	BZXH100WPTBJM20 400kg
	30	12	45	-	BZMH125WPTB12 300kg	-
	30	15	30	-	-	BZH125WPTBJM15 300kg
	30	20	45	BZMH125WPTM20 300kg	-	-
	40	15	50	-	BZH125WPTB15 350kg	-
	40	23	50	BZH125WPTM23 350kg	-	-
150	40	20	50	-	-	BZH125WPTBJM20 400kg
	50	20	60	-	-	BZXH125WPTBJM20 500kg
	40	20	40	-	-	BZMH150WPTBJM20 500kg
	50	20	50	-	BZXH150WPTB12 750kg	BZXH150WPTBJM20 750kg
200	50	25.4	60	-	BZXH150WPTB12 750kg	-
	45	25	45	-	-	BZH200WPTBJM25 1000kg
	45	20	60	-	BZXH200WPTB12 1000kg	BZXH200WPTBJM20 1000kg
	45	25.4	60	-	BZXH200WPTB12 1000kg	-
250	75	30	82	-	-	BZXP200WPTBJM30 1600kg
	100	50	100	-	-	BZXXH200WPTBJM50 2000kg
	50	25	60	-	-	BZPMH250WPTBJM25 1200kg
	60	25	60	-	-	BZH250WPTBJM25 1400kg
300	75	30	82	-	-	BZXP250WPTBJM30 1800kg
	100	50	100	-	-	BZXXH250WPTBJM50 2500kg
	75	30	82	-	-	BZH300WPTBJM30 2200kg
400	100	50	108	-	-	BZXXH300WPTBJM50 3000kg
450	85	35	75	-	-	BZMH400WPTBJM50 3500kg
500	85	35	75	-	-	BZXH450WPTBJM35 4000kg
				-	-	BZXH500WPTBJM35 4500kg

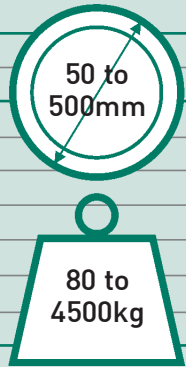

YELLOW POLYURETHANE SPEED WHEELS – 16 kph intermittent*

Wheel diameter (mm)	Tread width (mm)	Bore size (mm)	Hub length (mm)	Plain bearing	Needle roller bearing	Ball journal bearing
150	50	20	60	-	-	BZXH150WSPTBJM20 450kg**
200	50	20	60	-	-	BZXH200WSPTBJM20 650kg***

* hardness: 85 ± 3 Shore A

** at 16kph 180kg

*** at 16kph 260kg

Telephone 01249 822 222 www.bilgroup.eu



WPT/WSPT SERIES POLY/CAST IRON

350-775kg

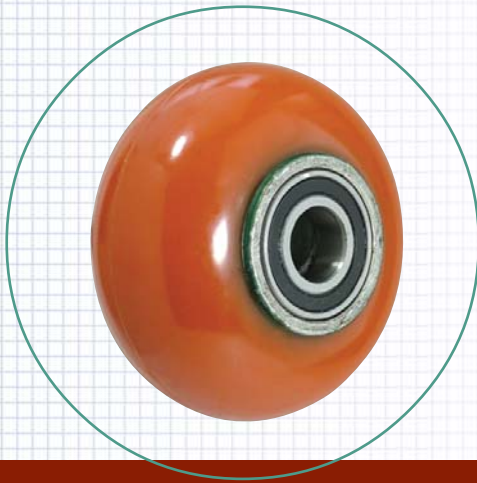

WRPTA SERIES

Brown polyurethane tyre on aluminium rim.

Hardness: 95 ± 2 Shore A

Temperature range: -20°C to +80°C

Wheel diameter (mm)	Tread width (mm)	Bore size (mm)	Hub length (mm)	Ball journal bearing
100	50	20	50	BZMH100WRPTABJM20 350kg
100	50	20	56	BZH100WRPTABJM20 350kg
125	50	20	56	BZH125WRPTABJM20 450kg
150	50	20	56	BZH150WRPTABJM20 575kg
200	50	20	56	BZH200WRPTABJM20 775kg

Wheel diameter (mm)	Tread width (mm)	Bore size (mm)	Hub length (mm)	Ball journal bearing
100	50	20	50	BZMH100WRPTABJM20 350kg
100	50	20	56	BZH100WRPTABJM20 350kg
125	50	20	56	BZH125WRPTABJM20 450kg
150	50	20	56	BZH150WRPTABJM20 575kg
200	50	20	56	BZH200WRPTABJM20 775kg

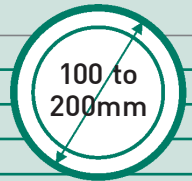

ERGONOMIC WHEELS

New ergonomic design wheels for effortless rolling with very low push-pull effort required to move loads. Generous amount of polyurethane is mechanically locked and chemically bonded to a metal core, ensuring excellent performance in the most demanding conditions.

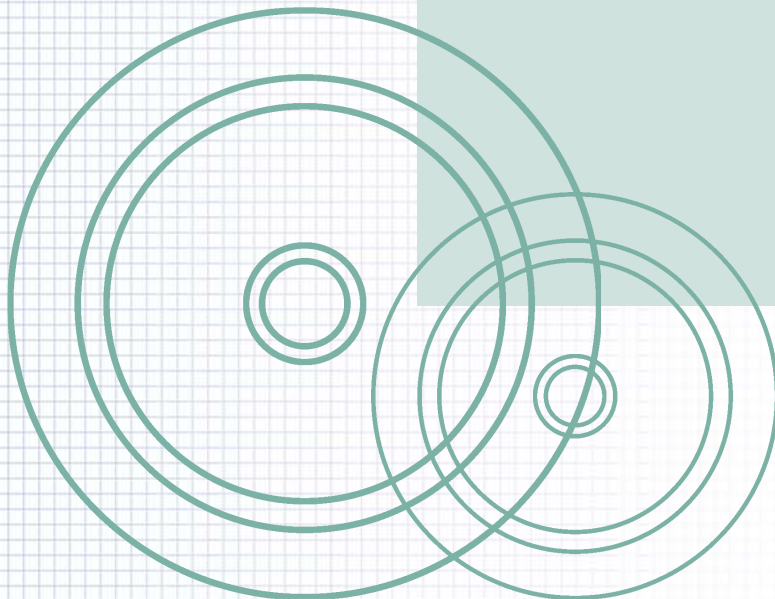

WRPTA SERIES POLY/ALUMINIUM

WPK SERIES

Blue solid elastomer tyre on aluminium core rim.

Hardness: 70 ± 2 Shore D
Temperature range: -20°C to +80°C

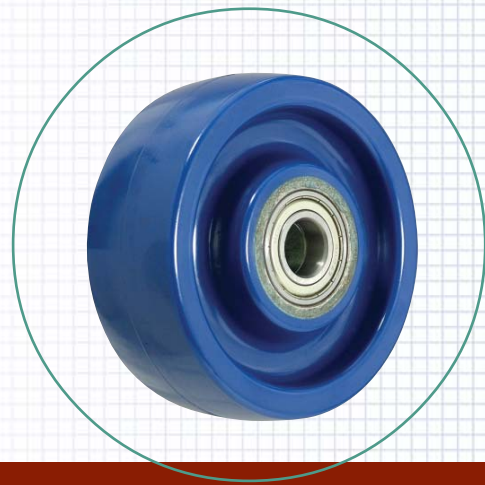

500-700kg

Wheel diameter (mm)	Tread width (mm)	Bore size (mm)	Hub length (mm)	Ball journal bearing
---------------------	------------------	----------------	-----------------	----------------------

125	50	20	56	BZH125WPKBJM20 500kg
150	50	20	56	BZH150WPKBJM20 550kg
200	50	20	56	BZH200WPKBJM20 700kg

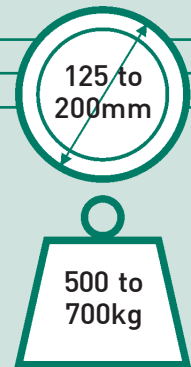

ELASTOMER WHEELS

'Real solid' elastomer wheels are made from premium liquid-cast urethane mechanically locked and chemically bonded to a metallic hub holding the bearings. Designed to resist compression set, these wheels have excellent resilience for easy movement and expulsion of floor debris. Can be used in rust-forming environments with a suitable hub and bearings.

WPK SERIES ELASTOMER/ALUMINIUM



80-100kg



WPUA SERIES

Non-marking anti-static grey thermoplastic polyurethane tyre on polypropylene rim.

Hardness: 90±2 Shore A

Temperature range: -20°C to +70°C

Wheel diameter (mm)	Tread width (mm)	Bore size (mm)	Hub length (mm)	Ball journal bearing
---------------------	------------------	----------------	-----------------	----------------------

100	32	8	36	BZM100WPUBJM8A 80kg
125	32	8	36	BZM125WPUBJM8A 100kg

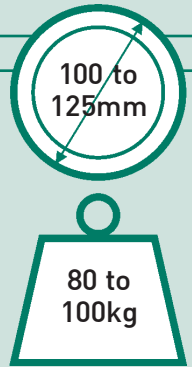

THERMOPLASTIC WHEELS

The thermoplastic polyurethane tyre tread is injected onto the central core with double mechanical anchoring. The central polyamide core has original DIN 625 bearings fitted which are supplied with 2RS water-proofing as standard.

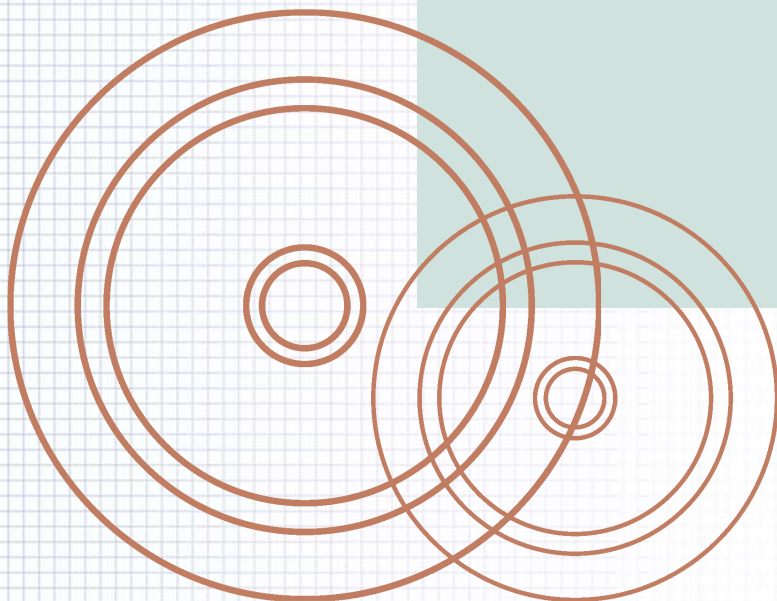

WPUA SERIES ANTI-STATIC

WAPA SERIES

Non-marking anti-static grey polyurethane tyre on aluminium rim.

Hardness: 91 ±3 Shore A
Temperature range: -20°C to +80°C

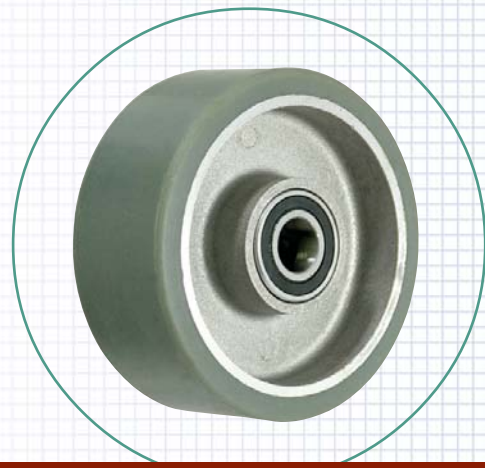

200-320kg

Wheel diameter (mm)	Tread width (mm)	Bore size (mm)	Hub length (mm)	Ball journal bearing
---------------------	------------------	----------------	-----------------	----------------------

100	40	15	40	BZH100WAPABJM15 200kg
125	40	20	50	BZH125WAPABJM20 240kg
150	40	20	40	BZH150WAPABJM20 320kg

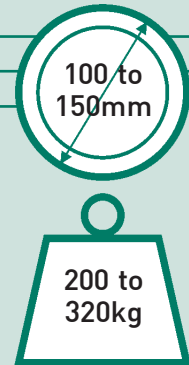

ANTI-STATIC WHEELS

The tyre tread is bonded to the aluminium core and can be fitted with 2RS bearings as standard. These wheels can be supplied with stainless steel bearings for use in stainless steel brackets – details on request.

WAPA SERIES ANTI-STATIC



75-200kg



WPP SERIES

Black pneumatic tyre on red polypropylene rim.

Wheel diameter (mm)	Tread width (mm)	Bore size (mm)	Hub length (mm)	PSI	Tyre ply	Tread pattern	Plain bearing	Needle roller bearing
---------------------	------------------	----------------	-----------------	-----	----------	---------------	---------------	-----------------------

200	50	20	60	30	2	R	-	BZWPPR200202R 75kg
		25	75	30	4	D	BZWPP260204D 120kg	BZWPPR260204D 120kg
260	85	25	75	30	4	D	BZWPP260254D 120kg	BZWPPR260254D 120kg
		25.4	75	30	4	D	BZWPP2602544D 120kg	BZWPPR2602544D 120kg
300	100	25	75	30	4	D	BZWPP300254D 155kg	BZWPPR300254D 155kg
		25.4	75	30	4	D	BZWPP3002544D 155kg	BZWPPR3002544D 155kg
370	85	25	75	30	2	R	-	BZWPPR370252R 120kg
		25	75	30	4	R	BZWPP400254R 200kg	BZWPPR400254R 200kg
400	105	25.4	75	30	4	R	BZWPP4002544R 200kg	BZWPPR4002544R 200kg
		25	75	30	4	D	-	BZWPPR400254D 200kg
		25.4	75	30	4	D	-	BZWPPR4002544D 200kg

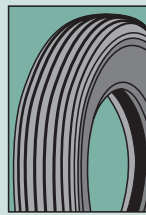
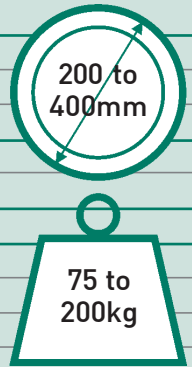

R Ribbed pattern



D Diamond pattern

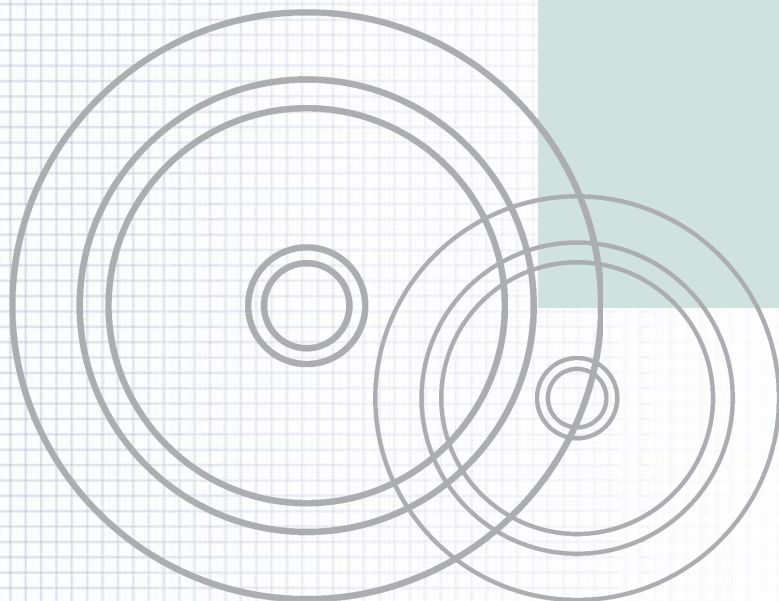

WPP SERIES PNEUMATIC/POLY

WPM SERIES

Black pneumatic tyre on welded-steel rim.
Available with grey- or red-painted centres.



75-300kg

Wheel diameter (mm)	Tread width (mm)	Bore size (mm)	Hub length (mm)	PSI	Tyre ply	Tread pattern	Grey centre needle roller bearing	Red centre needle roller bearing
---------------------	------------------	----------------	-----------------	-----	----------	---------------	-----------------------------------	----------------------------------

200	50	20	60	36	2	R	BZWPMR200202R 75kg	–
		25	65	36	4	D	–	BZWPMR26025654D 200kg
		25.4	65	36	4	D	–	BZWPMR260254654D 200kg
260	85	20	75	36	4	D	BZWPMR260204D 200kg	–
		25	75	36	4	D	BZWPMR260254D 200kg	–
		25.4	75	36	4	D	BZWPMR2602544D 200kg	–
		20	75	36	6	D	BZWPMR260206D 200kg	–
300	100	25	75	36	4	D	–	BZWPMR30025654D 250kg
		25	75	36	4	D	–	BZWPMR300254654D 250kg
		25	75	36	4	D	BZWPMR300254D 250kg	–
		25.4	75	36	4	D	BZWPMR3002544D 250kg	–
400	105	25	65	30	4	R	–	BZWPMR40025654R 250kg
		25.4	65	30	4	R	–	BZWPMR400254654R 250kg
		25.4	65	30	6	R	–	BZWPMR400254656R 300kg
		25	65	30	4	D	–	BZWPMR40025654D 300kg
		25.4	65	30	4	D	–	BZWPMR400254654D 300kg
		25	75	30	4	R	BZWPMR400254R 250kg	–
		25.4	75	30	4	R	BZWPMR4002544R 250kg	–
		25.4	75	30	6	R	BZWPMR4002546R 300kg	–
25	75	30	4	D	BZWPMR400254D 300kg	–		
25.4	75	30	4	D	BZWPMR4002544D 300kg	–		

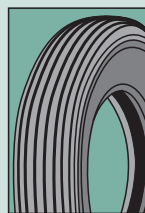
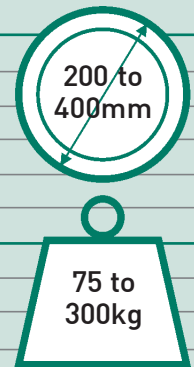

R Ribbed pattern



D Diamond pattern

WPM SERIES PNEUMATIC/STEEL



120-180kg



WPPU SERIES

Black, puncture-proof lightweight micro-cellular polyurethane tyre on red polypropylene rim.

Hardness: 78±5 Shore A
Temperature range: -10°C to +60°C

Wheel diameter (mm)	Tread width (mm)	Bore size (mm)	Hub length (mm)	Needle roller bearing
---------------------	------------------	----------------	-----------------	-----------------------

260	85	20	75	BZWPPUR26020 120kg
	85	25	75	BZWPPUR26025 120kg
	85	25.4	75	BZWPPUR260254 120kg
400	105	25	75	BZWPPUR40025 180kg
	105	25.4	75	BZWPPUR400254 180kg

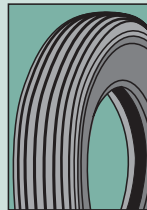
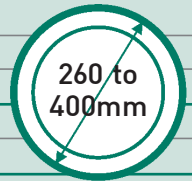

Ribbed pattern
standard



Diamond pattern
available on request

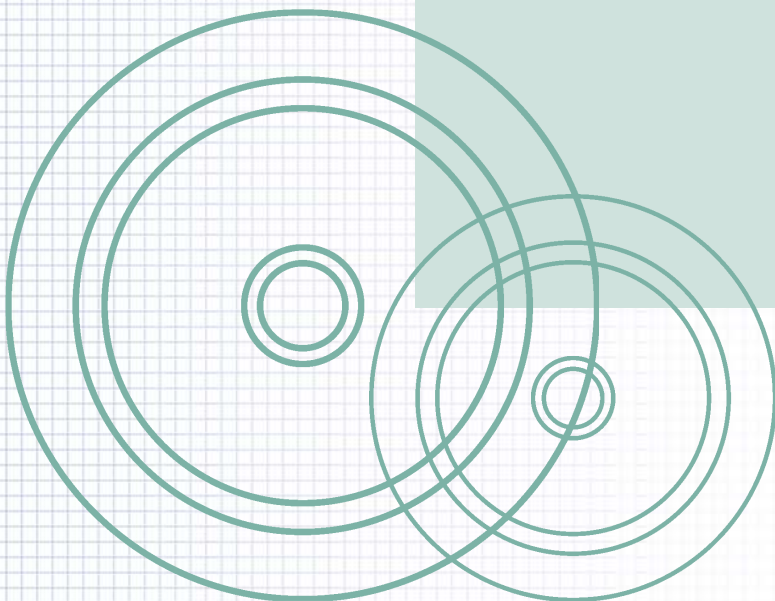

WPPU SERIES PUNCTURE-PROOF

WMPU SERIES

Black, puncture-proof lightweight micro-cellular polyurethane tyre on welded-steel rim.

Hardness: 78±5 Shore A
Temperature range: -10°C to +60°C



120-180kg

Wheel diameter (mm)	Tread width (mm)	Bore size (mm)	Hub length (mm)	Grey centre needle roller bearing	Red centre needle roller bearing
260	85	25	65	—	BZWMPUR2602565 120kg
	85	25.4	65	—	BZWMPUR26025465 120kg
	85	20	75	BZWMPUR26020 120kg	—
	85	25	75	BZWMPUR26025 120kg	—
	85	25.4	75	BZWMPUR260254 120kg	—
400	105	25	75	—	BZWMPUR4002565 180kg
	105	25.4	75	—	BZWMPUR40025465 180kg
	105	25	75	BZWMPUR40025 180kg	—
	105	25.4	75	BZWMPUR400254 180kg	—

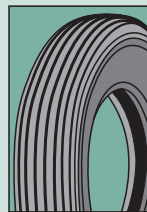
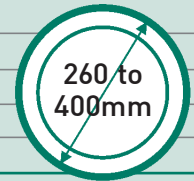

Ribbed pattern standard



Diamond pattern available on request

WMPU SERIES PUNCTURE-PROOF





STEER WHEELS

Pallet truck steer-wheels, either solid nylon (polyamide 6), solid polyurethane or elastic rubber on nylon (polyamide 6) on an aluminium core.

Can be supplied without bearings or with ball bearings fitted.

Wheel diameter (mm)	Tread width (mm)	Bore size (mm)	Hub length (mm)	Bearing seat (mm)	Without bearing	With ball bearing fitted
---------------------	------------------	----------------	-----------------	-------------------	-----------------	--------------------------

SOLID WHITE NYLON

	50	20	60	47 × 14	BZH175WNYBJ 560kg	BZH175WNYBJM20 560kg
175	50	20	60	47 × 15/20	BZH175WNYBJBT 560kg	BZH175WNYBJM20BT 560kg
	55	N/A	60	Closed end	BZH175WNYBJDE 600kg	—
200	50	20	60	47 × 16	BZH200WNYBJ60 650kg	BZH200WNYBJM2060 650kg

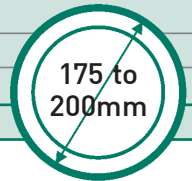

BLACK ELASTIC RUBBER ON ALUMINIUM CENTRE

180	50	20	60	47 × 14	BZH180WERBJ 350kg	BZH180WERBJM20 350kg
200	50	20	60	47 × 14	BZH200WERBJ 350kg	BZH200WERBJM20 450kg
	50	—	60	47 × 20	BZH200WERBJ47X20 450kg	—



BROWN POLYURETHANE ON WHITE NYLON CENTRE

175	55	N/A	60	Closed end	BZH175WPNBJDE 600kg	—
200	50	20	58	47 × 14	BZH200WPNBJ 450kg	BZH200WPNBJM20 450kg

For ball bearings please see page 113

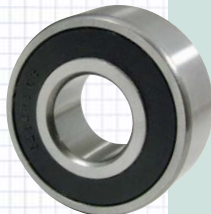

PALLET ROLLERS

Pallet rollers, either solid nylon (polyamide 6) or polyurethane tyres on nylon (polyamide 6) or steel core.

Can be supplied with or without ball bearings fitted.

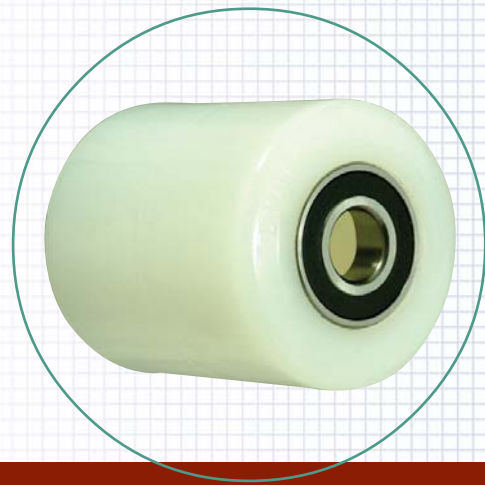

500-950kg

Wheel diameter (mm)	Tread width (mm)	Bore size (mm)	Hub length (mm)	Bearing seat (mm)	Without bearing	With ball bearing fitted
---------------------	------------------	----------------	-----------------	-------------------	-----------------	--------------------------

SOLID WHITE NYLON

82	60	20	60	47 × 14	BZH8260WNYBJ 500kg	BZH8260WNYBJM20 500kg
	70	20	70	47 × 14	BZH8270WNYBJ 600kg	BZH8270WNYBJM20 600kg
	75	20	75	47 × 14	BZH8275WNYBJ 700kg	BZH8275WNYBJM20 700kg
	80	20	80	47 × 14	BZH8280WNYBJ 700kg	BZH8280WNYBJM20 700kg
	90	20	90	47 × 14	BZH8290WNYBJ 800kg	BZH8290WNYBJM20 800kg
85	100	20	100	47 × 16	BZH82100WNYBJ 950kg	BZH82100WNYBJM20 950kg
	70	20	70	47 × 14	BZH8570WNYBJ 650kg	BZH8570WNYBJM20 650kg
	80	20	80	47 × 14	BZH8580WNYBJ 750kg	BZH8580WNYBJM20 750kg
	90	20	90	47 × 14	BZH8590WNYBJ 850kg	BZH8590WNYBJM20 850kg
	100	20	100	47 × 14	BZH85100WNYBJ 950kg	BZH85100WNYBJM20 950kg

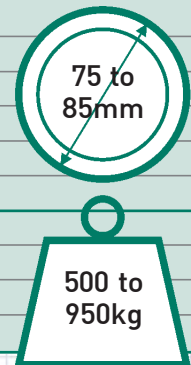

POLYURETHANE TYRE ON NYLON CENTRE

82	60	20	60	47 × 14	BZH8260WPNB 500kg	BZH8260WPNBJM20 500kg
	70	20	70	47 × 14	BZH8270WPNB 550kg	BZH8270WPNBJM20 550kg
	90	20	90	47 × 14	BZH8290WPNB 650kg	BZH8290WPNBJM20 650kg
	100	20	100	47 × 14	BZH82100WPNB 750kg	BZH82100WPNBJM20 750kg



POLYURETHANE TYRE ON STEEL CENTRE

82	75	20	75	47 × 14	BZH7575WPTBJ 500kg	BZH7575WPTBJM20 500kg
	50	20	50	47 × 14	BZH8250WPTBJ 650kg	BZH8250WPTBJM20 650kg
	70	20	70	47 × 14	BZH8270WPTBJ 700kg	BZH8270WPTBJM20 700kg
	75	20	75	47 × 14	BZH8275WPTBJ 700kg	BZH8275WPTBJM20 700kg
	80	20	80	47 × 14	BZH8280WPTBJ 700kg	BZH8280WPTBJM20 700kg
85	90	20	90	47 × 14	BZH8290WPTBJ 850kg	BZH8290WPTBJM20 850kg
	100	20	100	47 × 14	BZH82100WPTBJ 950kg	BZH82100WPTBJM20 950kg
	70	20	70	47 × 14	BZH8570WPTBJ 700kg	BZH8570WPTBJM20 700kg
	75	20	75	47 × 14	BZH8575WPTBJ 700kg	BZH8575WPTBJM20 700kg
	80	20	80	47 × 14	BZH8580WPTBJ 700kg	BZH8580WPTBJM20 700kg
	90	20	90	47 × 14	BZH8590WPTBJ 850kg	BZH8590WPTBJM20 850kg
	100	20	100	47 × 14	BZH85100WPTBJ 950kg	BZH85100WPTBJM20 950kg

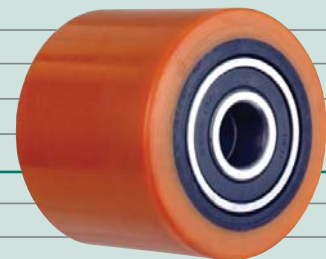

ROLLERS PALLET TRUCK



200-900kg



WCV SERIES

Black-painted cast-iron 90° v-groove wheels for use on inverted angle-iron tracks.

Wheel diameter (mm)	Width of groove (mm)	Depth of groove (mm)	Tread width (mm)	Bore size (mm)	Hub width (mm)	Needle roller bearing	Ball journal bearing
---------------------	----------------------	----------------------	------------------	----------------	----------------	-----------------------	----------------------

75	22	11	35	19.1	45	BZH75WCVRB19 200kg	-
100	22	11	50	20	60	-	BZH100WCVBJM20 360kg
125	22	11	50	20	60	-	BZH125WCVBJM20 675kg
150	32	15	50	20	60	-	BZ150WCVBJM20 700kg
200	22	11	50	20	60	-	BZH200WCVBJM20 900kg

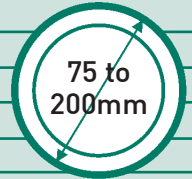

WCV SERIES CAST IRON V-GROOVE

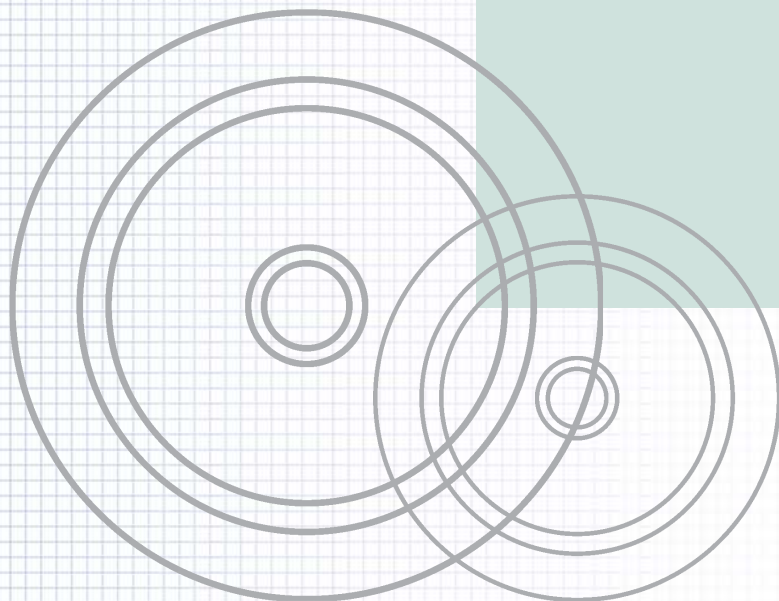

WCSF SERIES

Black-painted cast-iron flange wheels with 3° tread ascent.



800-1500kg

Wheel diameter (mm)	Wheel diameter inc flange	Wheel width inc flange	Tread width minus flange (mm)	Bore size (mm)	Hub width (mm)	Ball journal bearing
100	125	50	38	20	50	BZH100WCSFBJM20 800kg
125	145	50	38	20	50	BZH125WCSFBJM20 900kg
150	180	50	38	20	50	BZH150WCSFBJM20 1000kg
200	230	58	46	25	58	BZH200WCSFBJM25 1500kg

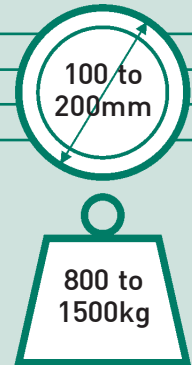

WCSF SERIES CAST IRON FLANGE

