

Castor wheel
manufacturers

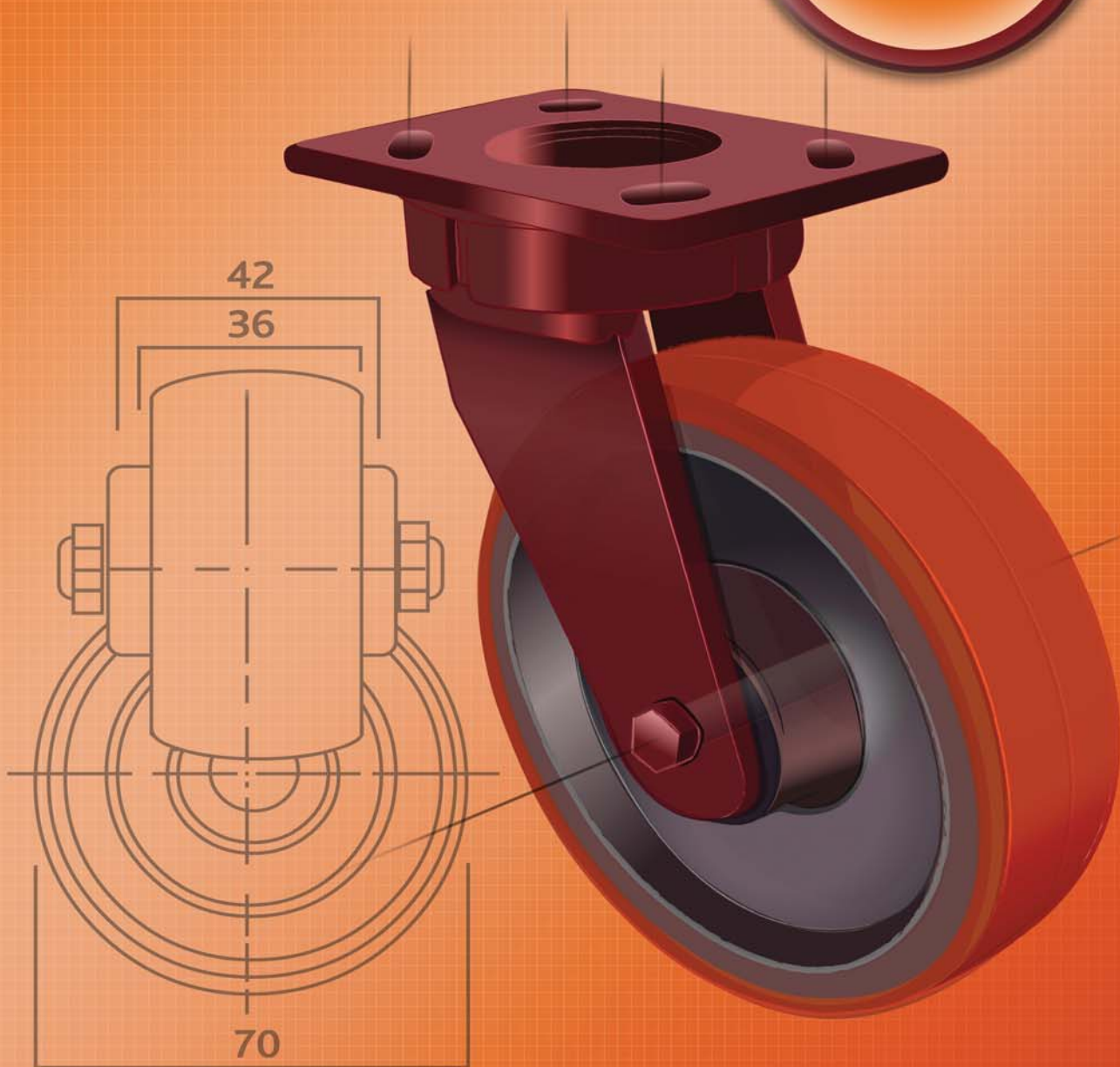

BAZROLL INTERNATIONAL LTD

Tel: 01249 822 222

www.bilgroup.eu



BZX/MH SERIES

Housing and plate made of zinc-plated, pressed steel with double ball race in swivelhead.

Available with top plate or single bolthole fixing.

| WHEEL CODE | | AN* | | TP | RNHT | | | | |
|-----------------|-----------------|------------------|---------------------|------------|--------------------|--------------|---------------------|--------------------|---------------------------------------|
| Wheel diam (mm) | Swivel or fixed | Tread width (mm) | Overall height (mm) | Plate type | Swivel radius (mm) | Bearing type | 300C black phenolic | 300C thermoplastic | 250C black elastic rubber on phenolic |

| | | | | | | | | | |
|-----|---|-------|-----|---|-----|--|----------------------|----------------------|-----------------------|
| 80 | S | 35 | 113 | A | 80 | | BZMH80AN3 150kg | – | – |
| | | | | | | | BZMH80AN3TF 150kg | – | – |
| 80 | F | 35 | 113 | A | – | | BZMHF80AN3 150kg | – | – |
| | | | | | | | BZMHF80AN3TF 150kg | – | – |
| 100 | S | 30 | 133 | A | 92 | | BZMH100AN3 180kg | BZMH100TP3 150kg | BZMH100RNHT 110kg |
| | | | | | | | BZMH100AN3TF 180kg | BZMH100TP3TF 150kg | BZMH100RNHTTF 110kg |
| | | | | | | | BZMH100ANBJ3 180kg | BZMH100TPBJ3 150kg | BZMH100RNBJHT 110kg |
| 100 | F | AN=35 | 133 | A | – | | BZMHF100AN3 180kg | BZMHF100TP3 150kg | BZMHF100RNHT 110kg |
| | | | | | | | BZMHF100AN3TF 180kg | BZMHF100TP3TF 150kg | BZMHF100RNHTTF 110kg |
| | | | | | | | BZMHF100ANBJ3 180kg | BZMHF100TPBJ3 150kg | BZMHF100RNBJHT 110kg |
| 100 | S | 30 | 135 | B | 92 | | BZMH100AN3LP 180kg | BZMH100TP3LP 150kg | BZMH100RNHTLP 110kg |
| | | | | | | | BZMH100AN3LPTF 180kg | BZMH100TP3LPTF 150kg | BZMH100RNHTLPTF 110kg |
| | | | | | | | BZMH100ANBJ3TF 180kg | BZMH100TPBJ3LP 150kg | BZMH100RNBJHTLP 110kg |
| 125 | S | 40 | 158 | A | 107 | | BZMH125AN3 200kg | – | – |
| 125 | F | | 158 | A | – | | BZMHF125AN3 200kg | – | – |
| 125 | S | | 160 | B | 107 | | BZMH125AN3LP 200kg | – | – |

No brakes available on this castor series

| | | | | | | | | | |
|-----|---|-------|-----|---|----|--|--------------------|--------------------|---------------------|
| 100 | S | 30 | 130 | A | 92 | | BZXM100AN3 150kg | BZXM100TP3 150kg | BZXM100RNHT 110kg |
| | | | | | | | BZXM100AN3TF 150kg | BZXM100TP3TF 150kg | BZXM100RNHTTF 110kg |
| 100 | F | AN=35 | 130 | A | – | | BZXM100AN3 150kg | BZXM100TP3 150kg | BZXM100RNHT 110kg |
| | | | | | | | BZXM100AN3TF 150kg | BZXM100TP3TF 150kg | BZXM100RNHTTF 110kg |

No brakes available on this castor series

* also available to 350°C temperature specification
– details on request

Single bolthole castor (12mm)

add to code: **BH12**

WHEEL BEARING KEY

- Plain bore
- Teflon bush
- Ball journal

AVAILABLE WHEEL TYPES (for full wheel specifications refer to pages indicated)

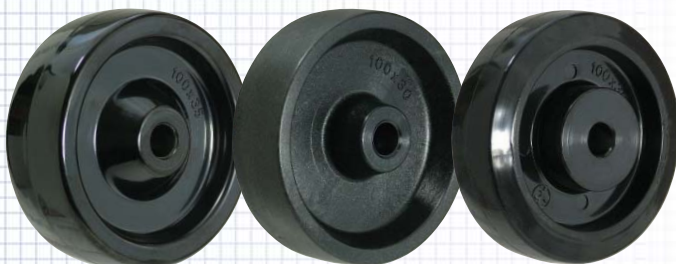

p82

p83

p83

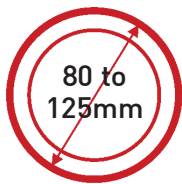

80 to
125mm



Bolt hole



110 to
200kg



Plate
fixing



110-200kg

PLATE TYPES AND DIMENSIONS (mm)

Type A

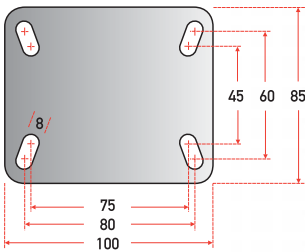

Type B

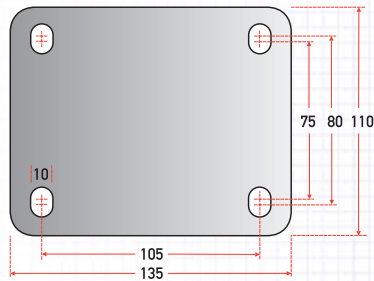

Single bolthole
add to code: BH12

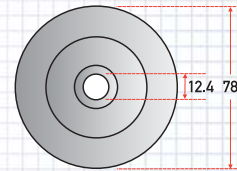

BZX/M/MH SERIES HIGH TEMP

















SSMH/XM SERIES

Housing made of pressed stainless steel (grade 304) with sealed double ball race in swivelhead.

Available with top plate or single bolthole fixing.

| WHEEL CODE | | | | | | AN* | TP | RNHT |
|-----------------|-----------------|------------------|---------------------|------------|--------------------|--------------|--------------------|---------------------------------------|
| Wheel diam (mm) | Swivel or fixed | Tread width (mm) | Overall height (mm) | Plate type | Swivel radius (mm) | Bearing type | 300C thermoplastic | 250C black elastic rubber on phenolic |

| | | | | | | | | |
|-----|---|-------------|-----|---|-----|--|----------------------|-----------------------|
| 80 | S | 35 | 113 | A | 80 |  SSMH80AN3 150kg | – | – |
| | | | | | |  SSMH80AN3TF 150kg | – | – |
| 80 | F | 35 | 113 | A | – |  SSMHF80AN3 150kg | – | – |
| | | | | | |  SSMHF80AN3TF 150kg | – | – |
| 100 | S | 30 AN=35 | 133 | A | 92 |  SSMH100AN3 180kg | SSMH100TP3 150kg | SSMH100RNHT 110kg |
| | | | | | |  SSMH100AN3TF 180kg | SSMH100TP3TF 150kg | SSMH100RNHTTF 110kg |
| 100 | F | 30 AN=35 | 133 | A | – |  SSMHF100AN3 180kg | SSMHF100TP3 150kg | SSMHF100RNHT 110kg |
| | | | | | |  SSMHF100AN3TF 180kg | SSMHF100TP3TF 150kg | SSMHF100RNHTTF 110kg |
| 100 | S | 30 AN=35 | 135 | B | 92 |  SSMH100AN3LP 180kg | SSMH100TP3LP 150kg | SSMH100RNHTLP 110kg |
| | | | | | |  SSMH100AN3LPTF 180kg | SSMH100TP3LPTF 150kg | SSMH100RNHTLPTF 110kg |
| 125 | S | 40 | 158 | A | 107 |  SSMH125AN3 200kg | – | – |
| 125 | F | | 158 | A | – |  SSMHF125AN3 200kg | – | – |
| 125 | S | | 160 | B | 107 |  SSMH125AN3LP 200kg | – | – |

No brakes available on this castor series

| | | | | | | | | |
|-----|---|-------------|-----|---|----|---|---------------------|----------------------|
| 100 | S | 30 AN=35 | 130 | A | 92 |  SSXM100AN3 160kg | SSXM100TP3 150kg | SSXM100RNHT 110kg |
| | | | | | |  SSXM100AN3TF 160kg | SSXM100TP3TF 150kg | SSXM100RNHTTF 110kg |
| 100 | F | 30 AN=35 | 130 | A | – |  SSXMF100AN3 160kg | SSXMF100TP3 150kg | SSXMF100RNHT 110kg |
| | | | | | |  SSXMF100AN3TF 160kg | SSXMF100TP3TF 150kg | SSXMF100RNHTTF 110kg |

No brakes available on this castor series

* also available to 350°C temperature specification
– details on request

Single bolthole castor (12mm)

add to code: **BH12**

WHEEL BEARING KEY

-  Plain bore
-  Teflon bush

AVAILABLE WHEEL TYPES (for full wheel specifications refer to pages indicated)

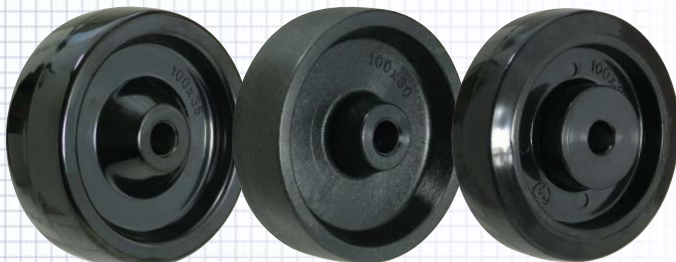

p82

p83

p83

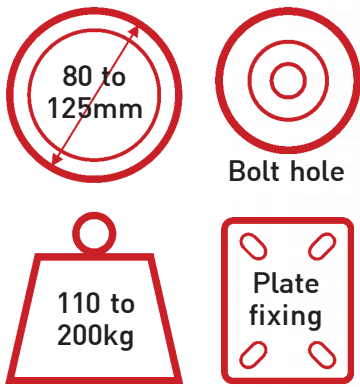

110-200kg

PLATE TYPES AND DIMENSIONS (mm)

Type A

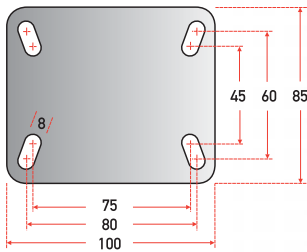

Type B

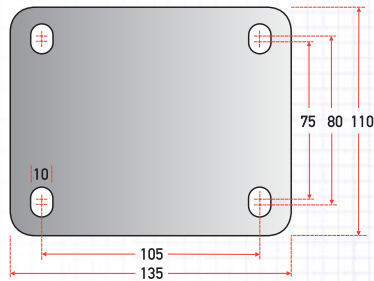

Single bolthole
add to code: BH12

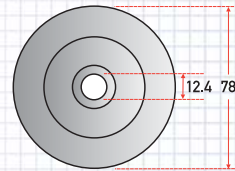

SSMH/XM SERIES HIGH TEMP

